



Republic of the Philippines
Department of Justice
BUREAU OF CORRECTIONS
Muntinlupa City



PHILIPPINE BIDDING DOCUMENTS

RENOVATION OF GSD FACILITY

(Procurement ID No. 020)

**Sixth Edition
July 2020
Bids and Awards Committee 2023**

TABLE OF CONTENTS

Section I. Invitation to Bid.....	3
Section II. Instructions to Bidders	6
Section III. Bid Data Sheet	13
Section IV. General Conditions of Contract	16
Section V. Special Conditions of Contract	21
Section VI. Specifications.....	23
Section VII. Drawings	26
Section VIII. Bill of Quantities.....	45
Section IX. Checklist of Technical and Financial Documents	47

Section I. Invitation to Bid



Republic of the Philippines
Department of Justice
BUREAU OF CORRECTIONS
Muntinlupa City



Invitation to Bid

RENOVATION OF GSD FACILITY

1. The **Bureau of Corrections**, through the General Appropriations Act (GAA) of 2023 intends to apply the sum of **Two Million Nine Hundred Twenty-Five Thousand Pesos Only (₱2,925,000.00)** being the Approved Budget for the Contract (ABC) to payments under the contract for **Renovation of GSD Facility with Identification Number 020**. Bids received in excess of the ABC shall be automatically rejected at bid opening.
2. The **Bureau of Corrections** now invites bids for the above Procurement Project. Completion of the Works is required within **one hundred eighty (180) calendar days** from the date of issuance of Notice to Proceed. Bidders should have completed a contract similar to the Project amounting to at **least fifty percent (50%)** of the ABC within the last four (4) years. The description of an eligible bidder is contained in the Bidding Documents, particularly, in Section II (Instructions to Bidders).
3. Bidding will be conducted through open competitive bidding procedures using non-discretionary “*pass/fail*” criterion as specified in the 2016 revised Implementing Rules and Regulations (IRR) of Republic Act (RA) No. 9184.
4. Interested bidders may obtain further information from **Bureau of Corrections** and inspect the Bidding Documents at the address given below from Monday to Friday from 8:00am to 5:00pm.
5. A complete set of Bidding Documents may be acquired by interested Bidders on **25 September 2023 to 18 October 2023 (12:59 PM)** from the given address and website(s) below. It may also be downloaded free of charge from the website of the Philippine Government Electronic Procurement System (PhilGEPS) and the website of the Procuring Entity bucor.gov.ph, provided that Bidders shall pay the applicable fee of **Five Thousand (₱5,000.00) Pesos Only** for the Bidding Documents not later than the submission of their bids. The Procuring Entity shall allow the bidder to present its proof of payment for the fees in person or by facsimile.
6. The **Bureau of Corrections** will hold a Pre-Bid Conference on **03 October 2023, 01:30 PM** at BAC Conference Room NBP Reservation Muntinlupa City, which shall be open to prospective bidders.
7. Bids must be duly received by the BAC Secretariat through manual submission at the office address as indicated below, on or before **18 October 2023, 1:00 PM**. Late bids shall not be accepted.

8. All bids must be accompanied by a bid security in any of the acceptable forms and in the amount stated in **ITB** Clause 15.
9. Bid opening shall be on **18 October 2023, 1:00 PM** at the BAC Conference Room NBP Reservation Muntinlupa City. Bids will be opened in the presence of the bidders' representatives who choose to attend the activity.
10. The **Bureau of Corrections** reserves the right to reject any and all bids, declare a failure of bidding, or not award the contract at any time prior to contract award in accordance with Sections 35.6 and 41 of the 2016 revised Implementing Rules and Regulations (IRR) of RA No. 9184, without thereby incurring any liability to the affected bidder or bidders.
11. For further information, please refer to:

MARIA ADORACION I. VIÑAS
Office of the BAC Secretariat
Supply Office, Bureau of Corrections, Muntinlupa City
Tel # 02-8809-8587/02-8478-0907
bacsec2022@gmail.com
13. You may visit the following websites:
For downloading of Bidding Documents: bucor.gov.ph

Date of Issue: **25 September 2023**

CCSUPT CELSO S BRAVO
Chairman, Bids and Awards Committee

CERTIFICATION

The Schedule of Requirements and Technical Specifications are in conformity with the requirements of the end-user unit:

This Procurement Project is covered by an Approved Annual Procurement Plan:

CSUPT RAUL P LEVITA
End-User Representative

MARIA ADORACION I VINAS
Head, BAC Secretariat

Prepared by:

Approved for release by:

CTO3 ALEXIS CATINDIG
Member, Technical Working Group

WILLIAM M TERRADO
Head, Technical Working Group

Section II. Instructions to Bidders

1. Scope of Bid

The Procuring Entity, **Bureau of Corrections** invites Bids for the **Renovation of GSD Facility**, with Project Identification Number *[indicate number]*.

[Note: The Project Identification Number is assigned by the Procuring Entity based on its own coding scheme and is not the same as the PhilGEPS reference number, which is generated after the posting of the bid opportunity on the PhilGEPS website.]

The Procurement Project (referred to herein as “Project”) is for the construction of Works, as described in Section VI (Specifications).

2. Funding Information

2.1. The GOP through the source of funding through the General Appropriations Act (GAA) of 2023 in the amount of **Two Million Nine Hundred Twenty-Five Thousand Pesos Only (₱2,925,000.00)**.

2.2. The source of funding is:

- a. NGA, the General Appropriations Act or Special Appropriations.

3. Bidding Requirements

The Bidding for the Project shall be governed by all the provisions of RA No. 9184 and its 2016 revised IRR, including its Generic Procurement Manual and associated policies, rules and regulations as the primary source thereof, while the herein clauses shall serve as the secondary source thereof.

Any amendments made to the IRR and other GPPB issuances shall be applicable only to the ongoing posting, advertisement, or invitation to bid by the BAC through the issuance of a supplemental or bid bulletin.

The Bidder, by the act of submitting its Bid, shall be deemed to have inspected the site, determined the general characteristics of the contracted Works and the conditions for this Project, such as the location and the nature of the work; (b) climatic conditions; (c) transportation facilities; (c) nature and condition of the terrain, geological conditions at the site communication facilities, requirements, location and availability of construction aggregates and other materials, labor, water, electric power and access roads; and (d) other factors that may affect the cost, duration and execution or implementation of the contract, project, or work and examine all instructions, forms, terms, and project requirements in the Bidding Documents.

4. Corrupt, Fraudulent, Collusive, Coercive, and Obstructive Practices

The Procuring Entity, as well as the Bidders and Contractors, shall observe the highest standard of ethics during the procurement and execution of the contract. They or through an agent shall not engage in corrupt, fraudulent, collusive, coercive, and

obstructive practices defined under Annex “I” of the 2016 revised IRR of RA No. 9184 or other integrity violations in competing for the Project.

5. Eligible Bidders

- 5.1. Only Bids of Bidders found to be legally, technically, and financially capable will be evaluated.
- 5.2. The Bidder must have an experience of having completed a Single Largest Completed Contract (SLCC) that is similar to this Project, equivalent to at least fifty percent (50%) of the ABC adjusted, if necessary, by the Bidder to current prices using the PSA’s CPI, except under conditions provided for in Section 23.4.2.4 of the 2016 revised IRR of RA No. 9184.

A contract is considered to be “similar” to the contract to be bid if it has the major categories of work stated in the **BDS**.
- 5.3. For Foreign-funded Procurement, the Procuring Entity and the foreign government/foreign or international financing institution may agree on another track record requirement, as specified in the Bidding Document prepared for this purpose.
- 5.4. The Bidders shall comply with the eligibility criteria under Section 23.4.2 of the 2016 IRR of RA No. 9184.

6. Origin of Associated Goods

There is no restriction on the origin of Goods other than those prohibited by a decision of the UN Security Council taken under Chapter VII of the Charter of the UN.

7. Subcontracts

- 7.1. The Bidder may subcontract portions of the Project to the extent allowed by the Procuring Entity as stated herein, but in no case more than fifty percent (50%) of the Project.

The Procuring Entity has prescribed that:

- a. Subcontracting is not allowed.
- 7.1. *[If Procuring Entity has determined that subcontracting is allowed during the bidding, state:]* The Bidder must submit together with its Bid the documentary requirements of the subcontractor(s) complying with the eligibility criteria stated in **ITB** Clause 5 in accordance with Section 23.4 of the 2016 revised IRR of RA No. 9184 pursuant to Section 23.1 thereof.
 - 7.2. *[If subcontracting is allowed during the contract implementation stage, state:]* The Supplier may identify its subcontractor during the contract implementation stage. Subcontractors identified during the bidding may be changed during the implementation of this Contract. Subcontractors must submit the documentary

requirements under Section 23.1 of the 2016 revised IRR of RA No. 9184 and comply with the eligibility criteria specified in **ITB** Clause 5 to the implementing or end-user unit.

- 7.3. Subcontracting of any portion of the Project does not relieve the Contractor of any liability or obligation under the Contract. The Supplier will be responsible for the acts, defaults, and negligence of any subcontractor, its agents, servants, or workmen as fully as if these were the Contractor's own acts, defaults, or negligence, or those of its agents, servants, or workmen.

8. Pre-Bid Conference

The Procuring Entity will hold a pre-bid conference for this Project on the specified date and time and either at its physical address at BAC Conference Room NBP Reservation Muntinlupa City and/or through videoconferencing/webcasting} as indicated in paragraph 6 of the **IB**.

9. Clarification and Amendment of Bidding Documents

Prospective bidders may request for clarification on and/or interpretation of any part of the Bidding Documents. Such requests must be in writing and received by the Procuring Entity, either at its given address or through electronic mail indicated in the **IB**, at least ten (10) calendar days before the deadline set for the submission and receipt of Bids.

10. Documents Comprising the Bid: Eligibility and Technical Components

- 10.1. The first envelope shall contain the eligibility and technical documents of the Bid as specified in **Section IX. Checklist of Technical and Financial Documents**.
- 10.2. If the eligibility requirements or statements, the bids, and all other documents for submission to the BAC are in foreign language other than English, it must be accompanied by a translation in English, which shall be authenticated by the appropriate Philippine foreign service establishment, post, or the equivalent office having jurisdiction over the foreign bidder's affairs in the Philippines. For Contracting Parties to the Apostille Convention, only the translated documents shall be authenticated through an apostille pursuant to GPPB Resolution No. 13-2019 dated 23 May 2019. The English translation shall govern, for purposes of interpretation of the bid.
- 10.3. A valid PCAB License is required, and in case of joint ventures, a valid special PCAB License, and registration for the type and cost of the contract for this Project. Any additional type of Contractor license or permit shall be indicated in the **BDS**.
- 10.4. A List of Contractor's key personnel (e.g., Project Manager, Project Engineers, Materials Engineers, and Foremen) assigned to the contract to be bid, with their

complete qualification and experience data shall be provided. These key personnel must meet the required minimum years of experience set in the **BDS**.

- 10.5. A List of Contractor's major equipment units, which are owned, leased, and/or under purchase agreements, supported by proof of ownership, certification of availability of equipment from the equipment lessor/vendor for the duration of the project, as the case may be, must meet the minimum requirements for the contract set in the **BDS**.

11. Documents Comprising the Bid: Financial Component

- 11.1. The second bid envelope shall contain the financial documents for the Bid as specified in **Section IX. Checklist of Technical and Financial Documents**.
- 11.2. Any bid exceeding the ABC indicated in paragraph 1 of the **IB** shall not be accepted.
- 11.3. For Foreign-funded procurement, a ceiling may be applied to bid prices provided the conditions are met under Section 31.2 of the 2016 revised IRR of RA No. 9184.

12. Alternative Bids

Bidders shall submit offers that comply with the requirements of the Bidding Documents, including the basic technical design as indicated in the drawings and specifications. Unless there is a value engineering clause in the **BDS**, alternative Bids shall not be accepted.

13. Bid Prices

All bid prices for the given scope of work in the Project as awarded shall be considered as fixed prices, and therefore not subject to price escalation during contract implementation, except under extraordinary circumstances as determined by the NEDA and approved by the GPPB pursuant to the revised Guidelines for Contract Price Escalation guidelines.

14. Bid and Payment Currencies

- 14.1. Bid prices may be quoted in the local currency or tradable currency accepted by the BSP at the discretion of the Bidder. However, for purposes of bid evaluation, Bids denominated in foreign currencies shall be converted to Philippine currency based on the exchange rate as published in the BSP reference rate bulletin on the day of the bid opening.
- 14.2. *Payment of the contract price shall be made in:*

- a. Philippine Pesos.

15. Bid Security

- 15.1. The Bidder shall submit a Bid Securing Declaration or any form of Bid Security in the amount indicated in the **BDS**, which shall be not less than the percentage of the ABC in accordance with the schedule in the **BDS**.
- 15.2. The Bid and bid security shall be valid until **one hundred twenty (120) calendar days**. Any bid not accompanied by an acceptable bid security shall be rejected by the Procuring Entity as non-responsive.

16. Sealing and Marking of Bids

Each Bidder shall submit one copy of the first and second components of its Bid.

The Procuring Entity may request additional hard copies and/or electronic copies of the Bid. However, failure of the Bidders to comply with the said request shall not be a ground for disqualification.

If the Procuring Entity allows the submission of bids through online submission to the given website or any other electronic means, the Bidder shall submit an electronic copy of its Bid, which must be digitally signed. An electronic copy that cannot be opened or is corrupted shall be considered non-responsive and, thus, automatically disqualified.

17. Deadline for Submission of Bids

The Bidders shall submit on the specified date and time and either at its physical address or through online submission as indicated in paragraph 7 of the **IB**.

18. Opening and Preliminary Examination of Bids

- 18.1. The BAC shall open the Bids in public at the time, on the date, and at the place specified in paragraph 9 of the **IB**. The Bidders' representatives who are present shall sign a register evidencing their attendance. In case videoconferencing, webcasting or other similar technologies will be used, attendance of participants shall likewise be recorded by the BAC Secretariat.

In case the Bids cannot be opened as scheduled due to justifiable reasons, the rescheduling requirements under Section 29 of the 2016 revised IRR of RA No. 9184 shall prevail.

- 18.2. The preliminary examination of Bids shall be governed by Section 30 of the 2016 revised IRR of RA No. 9184.

19. Detailed Evaluation and Comparison of Bids

- 19.1. The Procuring Entity's BAC shall immediately conduct a detailed evaluation of all Bids rated "*passed*" using non-discretionary pass/fail criteria. The BAC shall consider the conditions in the evaluation of Bids under Section 32.2 of 2016 revised IRR of RA No. 9184.

- 19.2. If the Project allows partial bids, all Bids and combinations of Bids as indicated in the **BDS** shall be received by the same deadline and opened and evaluated simultaneously so as to determine the Bid or combination of Bids offering the lowest calculated cost to the Procuring Entity. Bid Security as required by **ITB** Clause 16 shall be submitted for each contract (lot) separately.
- 19.3. In all cases, the NFCC computation pursuant to Section 23.4.2.6 of the 2016 revised IRR of RA No. 9184 must be sufficient for the total of the ABCs for all the lots participated in by the prospective Bidder.

20. Post Qualification

Within a non-extendible period of five (5) calendar days from receipt by the Bidder of the notice from the BAC that it submitted the Lowest Calculated Bid, the Bidder shall submit its latest income and business tax returns filed and paid through the BIR Electronic Filing and Payment System (eFPS), and other appropriate licenses and permits required by law and stated in the **BDS**.

21. Signing of the Contract

The documents required in Section 37.2 of the 2016 revised IRR of RA No. 9184 shall form part of the Contract. Additional Contract documents are indicated in the **BDS**.

Section III. Bid Data Sheet

Bid Data Sheet

ITB Clause			
5.2	For this purpose, contracts similar to the Project refer to contracts which have the same major categories of work, which shall be: Repair, Rehabilitation and Infrastructure/Construction Works.		
7.1	Subcontracting is not allowed		
10.3	A valid PCAB License is required, and in case of joint ventures, a valid special PCAB License, and registration for the type and cost of the contract for this Project.		
10.4	The key personnel must meet the required minimum years of experience set below:		
	<u>Key Personnel</u>	<u>General Experience</u>	<u>Relevant Experience</u>
	Project Manager	Duly licensed Civil Engineer/Architect with at least 5 years' experience	Similar or comparable projects, with knowledge in the application of rapid construction
	Foreman	with at least 5 years' experience as Foreman	Similar or comparable projects, with knowledge in the application of rapid construction
10.5	The minimum major equipment requirements are the following:		
	<u>Equipment</u>	<u>Capacity</u>	<u>Number of Units</u>
	Service Vehicle	For hauling of materials	One (1)
	Welding Machine	300 amp	Two (2)
12	No further instructions.		
15.1	The bid security shall be in the form of a Bid Securing Declaration or any of the following forms and amounts: a. The amount of not less than 2% of the ABC, if bid security is in cash, cashier's/manager's check, bank draft/guarantee or irrevocable letter of credit; b. The amount of not less than 5% of the ABC, if bid security is in Surety Bond.		
19.2	No further instructions.		
20	Within a non-extendible period of five (5) calendar days from receipt by the Bidder of the notice from the BAC that it submitted the Lowest Calculated Bid, the Bidder shall submit its;		

	<ol style="list-style-type: none"> 1. Latest income and business tax returns filed and paid through the BIR Electronic Filing and Payment System (eFPS) 2. Supporting Documents for the SLCC (Notice of Award and/or Notice to Proceed and Project Owner's Certificate of Final Acceptance issued by the Owner other than the Contractor or the Constructors Performance Evaluation System (CPES) Final Rating, which must be at least satisfactory. In case of contracts with the private sector, an equivalent document shall be submitted) 3. Valid and Current Registration Certificate (SEC Certificate of Registration for Corporation or DTI Certificate of Registration for Sole Proprietorship or CDA Certificate of Registration for Cooperative) 4. Valid and Current Mayor's or Business Permit 5. Valid and Current Tax Clearance 6. Valid and Current PCAB License and Registration 7. Audited Financial Statement
21	<ol style="list-style-type: none"> a. PERT/CPM or other acceptable tools of project scheduling b. Construction Methodology c. Manpower Utilization Schedule d. Equipment utilization Schedule

Section IV. General Conditions of Contract

1. **Scope of Contract**

This Contract shall include all such items, although not specifically mentioned, that can be reasonably inferred as being required for its completion as if such items were expressly mentioned herein. All the provisions of RA No. 9184 and its 2016 revised IRR, including the Generic Procurement Manual, and associated issuances, constitute the primary source for the terms and conditions of the Contract, and thus, applicable in contract implementation. Herein clauses shall serve as the secondary source for the terms and conditions of the Contract.

This is without prejudice to Sections 74.1 and 74.2 of the 2016 revised IRR of RA No. 9184 allowing the GPPB to amend the IRR, which shall be applied to all procurement activities, the advertisement, posting, or invitation of which were issued after the effectivity of the said amendment.

2. **Sectional Completion of Works**

If sectional completion is specified in the **Special Conditions of Contract (SCC)**, references in the Conditions of Contract to the Works, the Completion Date, and the Intended Completion Date shall apply to any Section of the Works (other than references to the Completion Date and Intended Completion Date for the whole of the Works).

3. **Possession of Site**

3.1 The Procuring Entity shall give possession of all or parts of the Site to the Contractor based on the schedule of delivery indicated in the **SCC**, which corresponds to the execution of the Works. If the Contractor suffers delay or incurs cost from failure on the part of the Procuring Entity to give possession in accordance with the terms of this clause, the Procuring Entity's Representative shall give the Contractor a Contract Time Extension and certify such sum as fair to cover the cost incurred, which sum shall be paid by Procuring Entity.

3.2 If possession of a portion is not given by the above date, the Procuring Entity will be deemed to have delayed the start of the relevant activities. The resulting adjustments in contract time to address such delay may be addressed through contract extension provided under Annex "E" of the 2016 revised IRR of RA No. 9184.

4. **The Contractor's Obligations**

The Contractor shall employ the key personnel named in the Schedule of Key Personnel indicating their designation, in accordance with **ITB** Clause 10.3 and specified in the **BDS**, to carry out the supervision of the Works.

The Procuring Entity will approve any proposed replacement of key personnel only if their relevant qualifications and abilities are equal to or better than those of the personnel listed in the Schedule.

5. **Performance Security**

- 5.1. Within ten (10) calendar days from receipt of the Notice of Award from the Procuring Entity but in no case later than the signing of the contract by both parties, the successful Bidder shall furnish the performance security in any of the forms prescribed in Section 39 of the 2016 revised IRR.
- 5.2. The Contractor, by entering into the Contract with the Procuring Entity, acknowledges the right of the Procuring Entity to institute action pursuant to RA No. 3688 against any subcontractor be they an individual, firm, partnership, corporation, or association supplying the Contractor with labor, materials and/or equipment for the performance of this Contract.

6. Site Investigation Reports

The Contractor, in preparing the Bid, shall rely on any Site Investigation Reports referred to in the SCC supplemented by any information obtained by the Contractor.

7. Warranty

- 7.1. In case the Contractor fails to undertake the repair works under Section 62.2.2 of the 2016 revised IRR, the Procuring Entity shall forfeit its performance security, subject its property (ies) to attachment or garnishment proceedings, and perpetually disqualify it from participating in any public bidding. All payables of the GOP in his favor shall be offset to recover the costs.
- 7.2. The warranty against Structural Defects/Failures, except that occasioned-on force majeure, shall cover the period from the date of issuance of the Certificate of Final Acceptance by the Procuring Entity. Specific duration of the warranty is found in the SCC.

8. Liability of the Contractor

Subject to additional provisions, if any, set forth in the SCC, the Contractor's liability under this Contract shall be as provided by the laws of the Republic of the Philippines.

If the Contractor is a joint venture, all partners to the joint venture shall be jointly and severally liable to the Procuring Entity.

9. Termination for Other Causes

Contract termination shall be initiated in case it is determined *prima facie* by the Procuring Entity that the Contractor has engaged, before, or during the implementation of the contract, in unlawful deeds and behaviors relative to contract acquisition and implementation, such as, but not limited to corrupt, fraudulent, collusive, coercive, and obstructive practices as stated in ITB Clause 4.

10. Dayworks

Subject to the guidelines on Variation Order in Annex “E” of the 2016 revised IRR of RA No. 9184, and if applicable as indicated in the **SCC**, the Dayworks rates in the Contractor’s Bid shall be used for small additional amounts of work only when the Procuring Entity’s Representative has given written instructions in advance for additional work to be paid for in that way.

11. Program of Work

11.1. The Contractor shall submit to the Procuring Entity’s Representative for approval the said Program of Work showing the general methods, arrangements, order, and timing for all the activities in the Works. The submissions of the Program of Work are indicated in the **SCC**.

11.2. The Contractor shall submit to the Procuring Entity’s Representative for approval an updated Program of Work at intervals no longer than the period stated in the **SCC**. If the Contractor does not submit an updated Program of Work within this period, the Procuring Entity’s Representative may withhold the amount stated in the **SCC** from the next payment certificate and continue to withhold this amount until the next payment after the date on which the overdue Program of Work has been submitted.

12. Instructions, Inspections and Audits

The Contractor shall permit the GOP or the Procuring Entity to inspect the Contractor’s accounts and records relating to the performance of the Contractor and to have them audited by auditors of the GOP or the Procuring Entity, as may be required.

13. Advance Payment

The Procuring Entity shall, upon a written request of the Contractor which shall be submitted as a Contract document, make an advance payment to the Contractor in an amount not exceeding fifteen percent (15%) of the total contract price, to be made in lump sum, or at the most two installments according to a schedule specified in the **SCC**, subject to the requirements in Annex “E” of the 2016 revised IRR of RA No. 9184.

14. Progress Payments

The Contractor may submit a request for payment for Work accomplished. Such requests for payment shall be verified and certified by the Procuring Entity’s Representative/Project Engineer. Except as otherwise stipulated in the **SCC**, materials and equipment delivered on the site but not completely put in place shall not be included for payment.

15. Operating and Maintenance Manuals

15.1. If required, the Contractor will provide “as built” Drawings and/or operating and maintenance manuals as specified in the **SCC**.

- 15.2. If the Contractor does not provide the Drawings and/or manuals by the dates stated above, or they do not receive the Procuring Entity's Representative's approval, the Procuring Entity's Representative may withhold the amount stated in the SCC from payments due to the Contractor.

Section V. Special Conditions of Contract

Special Conditions of Contract

GCC Clause	
2	Sectional completion is not applicable The Intended Completion Date is one hundred eighty (180) calendar days from the date of receipt of the NTP.
4.1	The Procuring Entity shall give possession of all parts of the Site to the Contractor from the date of the receipt of Notice to Proceed (NTP).
6	No further instructions.
7.2	Five (5) years.
10	No Dayworks are applicable to the contract.
11.1	The Contractor shall submit the Program of Work to the Procuring Entity's Representative within fourteen (14) days of delivery of the Notice of Award.
11.2	The amount to be withheld for late submission of an updated Program of Work is [<i>insert amount</i>].
13	The amount of the advance payment is The amount of the advance payment is Fifteen Percent (15%) of the contract price to be made in lump sum upon submission to and acceptance by the Bureau of Corrections of an irrevocable standby letter of credit of equivalent value from a commercial bank, a bank guarantee or a surety bond callable upon demand issued by a surety or insurance company duly licensed by the insurance commission and confirmed by the Bureau of Corrections.
14	Materials and equipment delivered on the site but not completely put in place shall not be included for payment.
15.1	The date by which operating and maintenance manuals are required is upon actual completion of the project. The date by which "as built" drawings are required is upon actual completion of the project.
15.2	The amount to be withheld for failing to produce "as built" drawings and/or operating and maintenance manuals by the date required is equivalent to five percent (5%) of the contract price.

Section VI. Specifications

SCOPE OF WORK	
RENOVATION OF GSD FACILITY	
BUREAU OF CORRECTIONS, NBP RESERVATION, MUNTINLUPA CITY	
CIVIL ENGINEERING UNIT	
ITEM	DESCRIPTION
No.	
1.0	General Requirements
	<i>Scope of Work:</i> 1. Temporary Facility and Field Office 2. Installation of Board Up Fence
1.1	Other General Requirements
	<i>Scope of Work:</i> 1. Mobilization/Demobilization 2. Site Clearing/Demolition/Disposal
1.2	Welding Works
	<i>Scope of Work:</i> 1. 5mm Angle Bar 2" x 2" x 6m shall be used in floor beam. 2. 5mm Angle Bar 1 1/2" x 1 1/2" x 6m shall be used in floor beam web member bracing. 3. 75mm GI Pipe Sched. 20 x 6m shall be used in steel post. 4. 2" x 4" x 2mm GI Tubular and 2" x 3" x 2mm GI Tubular shall be used in floor joist. 5. All steel fabrication must be painted with Epoxy primer. 6. All welded connection shall be properly grind on joints and welded portion.
1.3	Carpentry Works
	<i>Scope of Work:</i> 1. Replacement of entire ceiling w/ 4' x 8' x 9mm gypsum board. 2. 20mm x 50mm x 0.5mm Double Furring shall be used, Grid @ 0.4m o.c. 3. 12mm x 38mm x 0.7mm thk Carrying channel shall be used, Spa. @ 0.80m o.c. 4. Replacement of entire flooring w/ 4' x 8' x 3/4" Phenolic Board. 5. Replacement of entire exterior wall w/ 4' x 8' x 1/4" Fiber Cement Board. 6. Replacement of entire interior and partition wall w/ 4' x 8' x 9mm Gypsum Board. 7. Use of 1/2" thk Phenolic Board and 2x2 coco lumber for formworks. 8. Ensure the plumbness and the formworks durability if it's enough before pouring.
1.4	Civil/Structural Works
	<i>Scope of Works:</i> 1. Concreting of Slab on grade (thk=100mm), Beams, Columns and Footings. 2. Use 3000psi concrete compressive strength and 33psi for Rebar Strength. 3. Construction of new comfort room and septic tank.
1.5	Masonry Works
	<i>Scope of Works:</i> 1. Class "C" mix for cement mortar. 2. Laying of 5" CHB for CR Wall and Partition. 3. Use 10mm Rebar for Dowels (0.6m horizontal and 0.8m Vertical). 4. Plastering of new walls 16 mm THK 5. Laying of 4" CHB for CR Wall damages.
1.6	Roofing Works
	<i>Scope of Work:</i> 1. 2" x 4" x 2mm GI Tubular shall be used in Rafters, Span @ 1m o.c. 2. 2" x 3" x 1.2mm GI C-Purlins shall be used in battens, Span @ 0.60m o.c. 3. Installation of double side heat insulator covering the bathroom roof area 4. Application of elastomeric sealant in old and new roof. 5. Installation of 0.5mm long span pre-painted rib type roofing. 6. Sagrod using 10mm Ø Deformed bars.

Contract Duration: 180 calendar days

CONFORME:

Name of Company in Print

Signature Over Printed Name of Authorized Representative/Date

SCOPE OF WORK	
RENOVATION OF GSD FACILITY	
BUREAU OF CORRECTIONS, NBP RESERVATION, MUNTINLUPA CITY	
CIVIL ENGINEERING UNIT	
ITEM	DESCRIPTION
No.	
1.7	Tile Works
	<p><i>Scope of Work:</i></p> <ol style="list-style-type: none"> 1. Laying of Tiles including tile adhesive, grout. 2. Design must be approved by the end user. 3. All tiles must be properly layed. 4. Use cementitious waterproofing before the installtion of tiles.
1.8	Plumbing Works
	<p><i>Scope of Work:</i></p> <ol style="list-style-type: none"> 1. Installation of new Booster Pump, Pressure Tank and Water Storage Tank (branded/ high quality). 2. Installation of new water closet, kitchen sink, floor drain and lavatory (branded/ high quality). 3. Used 2° slope for waste line. 4. Used 2" Diameter PVC pipe for clean out, kitchen, lavatory and floor drain. 5. Used 4" Diameter PVC pipe for water closet. 6. Used 3/4" Diameter PPR pipe for water supply and 1/2" PPR Pipe for water distribution line.
1.9	Electrical Works
	<p><i>Scope of Work:</i></p> <ol style="list-style-type: none"> 1. All Electrical works shall comply in accordance w/ these plans and specifications. The applicable provision of the latest edition of Philippine Electrical Code (PEC) 2. The electrical works shall be done under the immediate supervision of a duly Registered Electrical Engineer 3. The contractor shall require to submit final test report that the completed project is free from any defect that warrant of workmanship, materials, and equipment. 4. All electrical work specified in the plan shall be included but not necessarily limited to supply, furnishing all labor and materials, tools and equipment and other related work, materials necessary to complete and functional electrical distribution system. 5. The materials and equipment to be use or install shall be brand new and no defect or damage. 6. If any of the materials, equipment and equipment become defective within the warranty period shall be immediately replace without any cost to the owner. 7. The contractor shall carry out the tapping of the electrical source from the main panel board to the main feeder of the new project properly. 8. All conduit of branch circuit shall be embedded in concrete or ceiling. 9. Supply and installation of new light switches. 10. Installation of new 1 unit(1hp), 1 unit(1.5hp) and 2 units(2.5hp) split type premium inverter air conditioning unit for GSD. 11. Installation of 150 meters 38mm. Sq. THVVN main feeder line with the assistance of Electrical Engineering Section.
1.10	Doors, Windows, Glass Partition and Furnitures
	<p><i>Scope of Works:</i></p> <ol style="list-style-type: none"> 1. Install as complete assemblies including door & window jambs,fin. Hardware & accessories 2. Install as complete assemblies and accessories of 10mm glazing tempered glass partition ang door. 3. All furnitures design must be approved by the end user. 4. Use high quality/branded furnitures and materials for accessories.
1.11	Paint Works
	<p><i>Scope of Work:</i></p> <ol style="list-style-type: none"> 1. Interior/exterior wall and ceiling shall be primed w/ solvent based primer atleast two(2) coats 2. Plastering of new walls / uneven walls w/ solvent based cast 3. Top coat paint shall be solvent based (semi gloss), atleast two(2) coats 4. All cracks must be retouched properly 5. Make sure that finished painting must be smooth and co cracks will be seen

Contract Duration: 180 calendar days

CONFORME:

Name of Company in Print

Signature Over Printed Name of Authorized Representative/Date

Section VII. Drawings





GSD OFFICE GSD OFFICE FLOOR PLAN
 SCALE 1:100

CONFORME:

Name of Company in Print

Signature Over Printed Name of Authorized Representative/Date

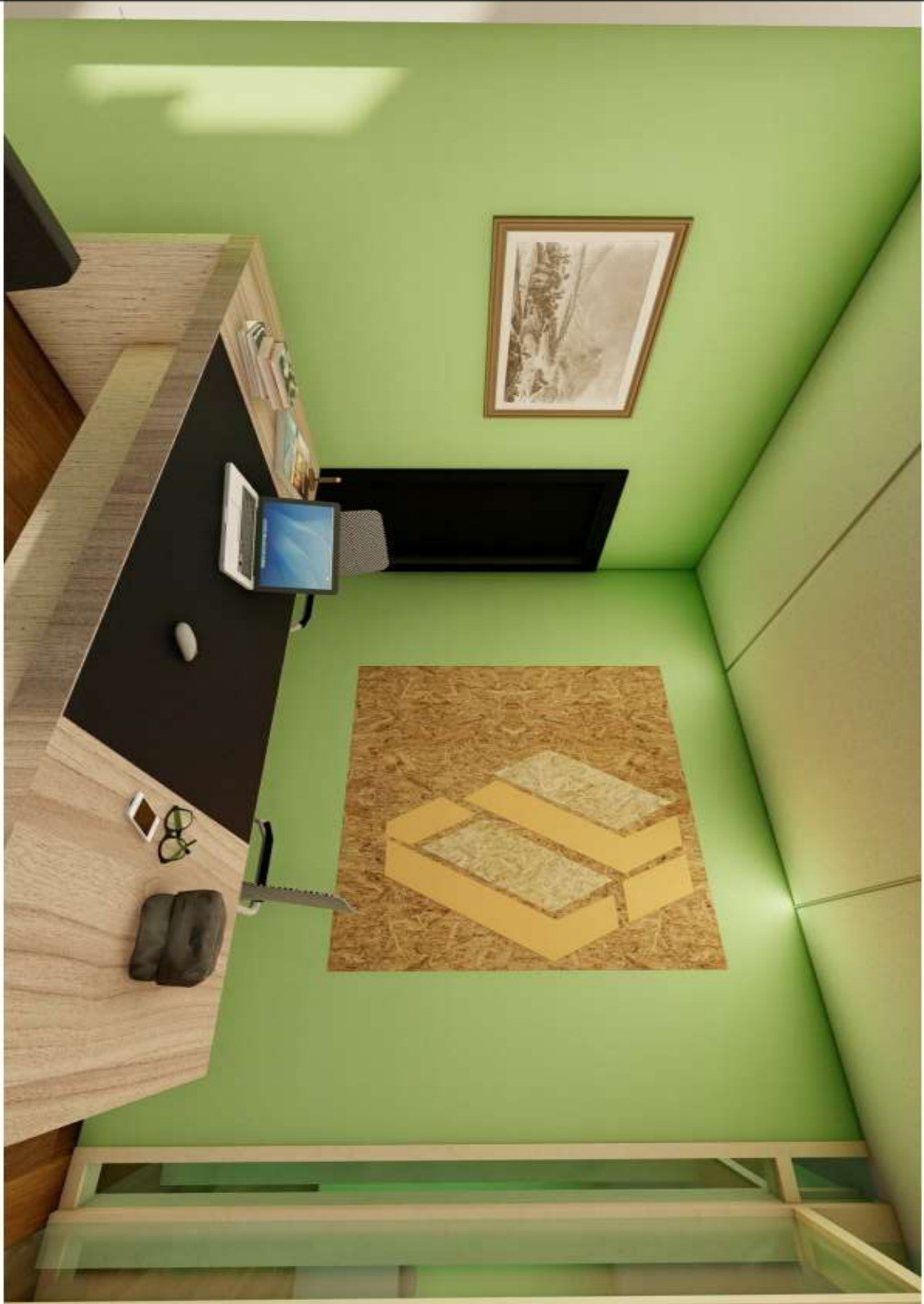
INTERIOR PERSPECTIVE (CHIEF GSD OFFICE)



CONFORME:

Name of Company in Print

Signature Over Printed Name of Authorized Representative/Date

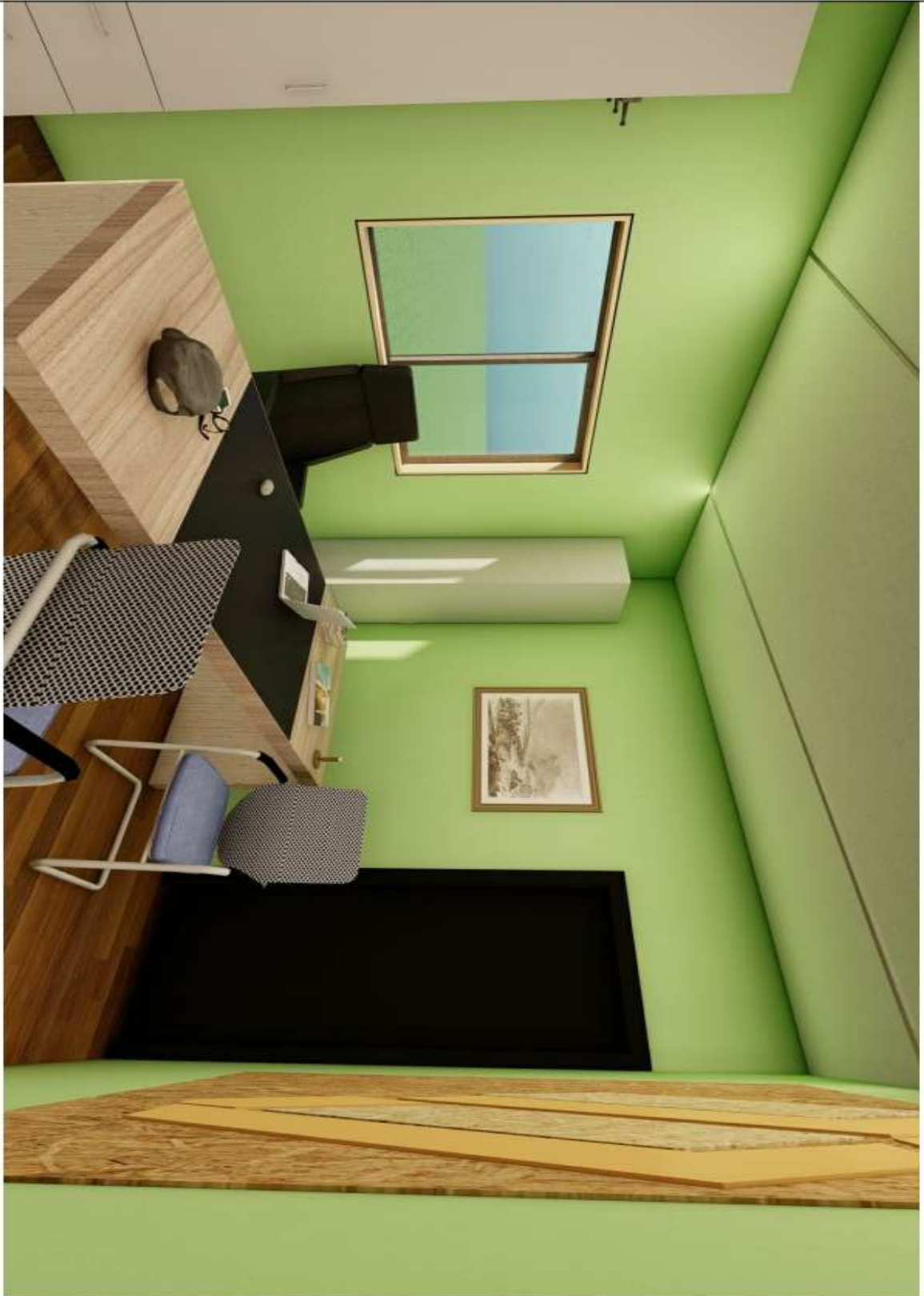

INTERIOR PERSPECTIVE (CHIEF GSD OFFICE)

CONFORME:

Name of Company in Print

Signature Over Printed Name of Authorized Representative/Date

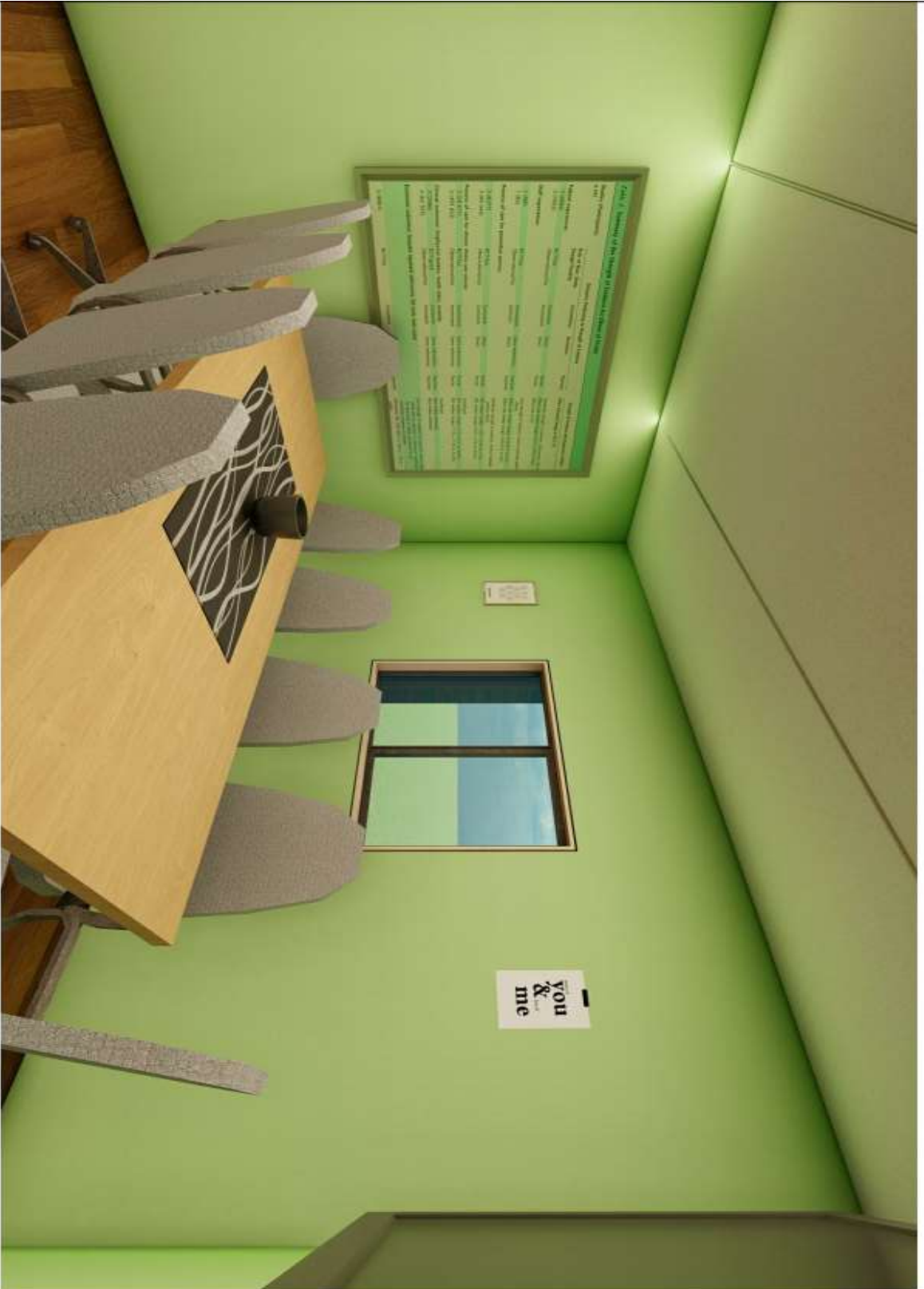

INTERIOR PERSPECTIVE (GSD CONFERENCE ROOM)

CONFORME:

Name of Company in Print

Signature Over Printed Name of Authorized Representative/Date

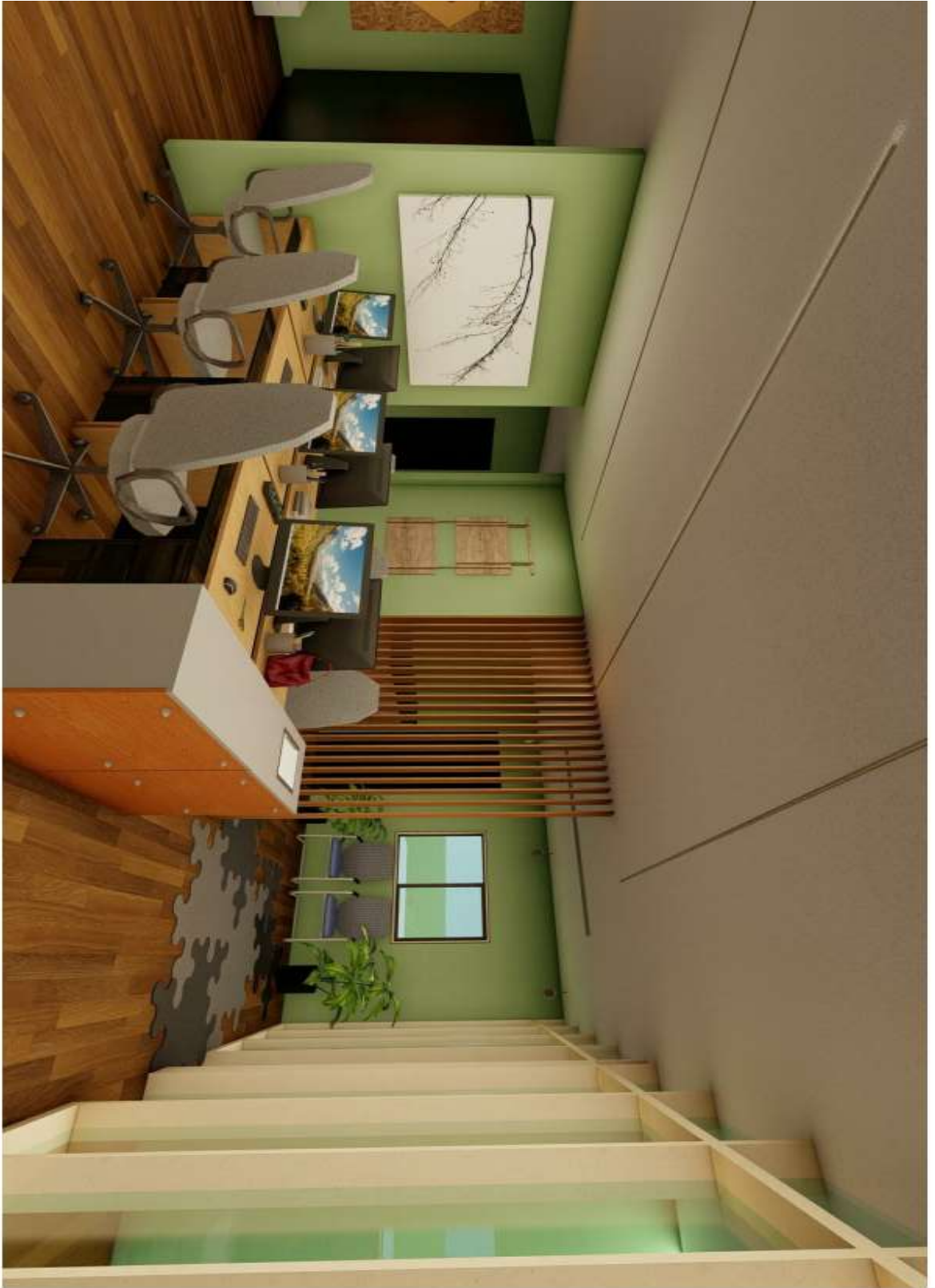

INTERIOR PERSPECTIVE (GSD WORKSTATION)

CONFORME:

Name of Company in Print

Signature Over Printed Name of Authorized Representative/Date

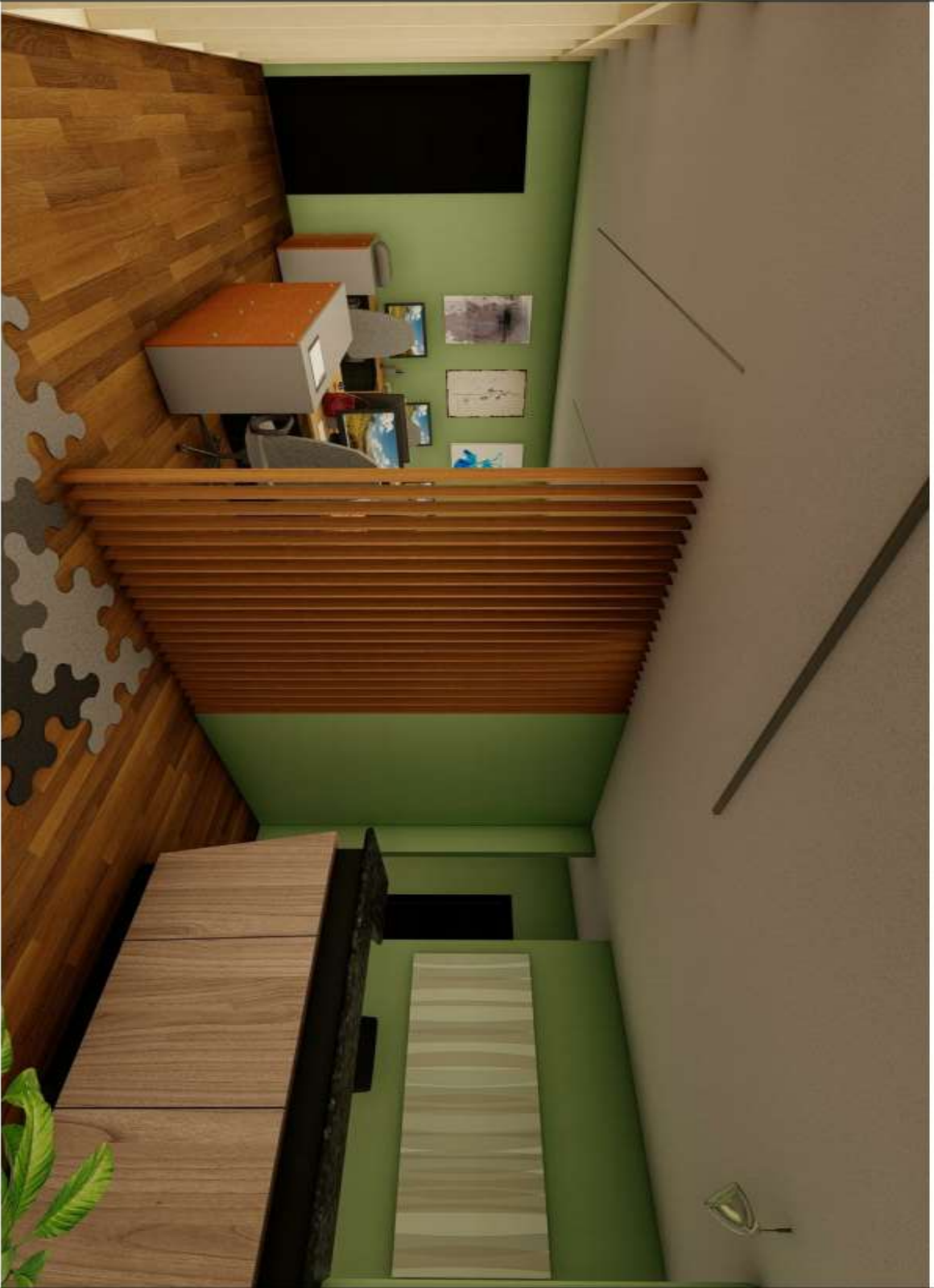

INTERIOR PERSPECTIVE (LOBBY)

CONFORME:

Name of Company in Print

Signature Over Printed Name of Authorized Representative/Date

RENOVATION OF GSD FACILITY

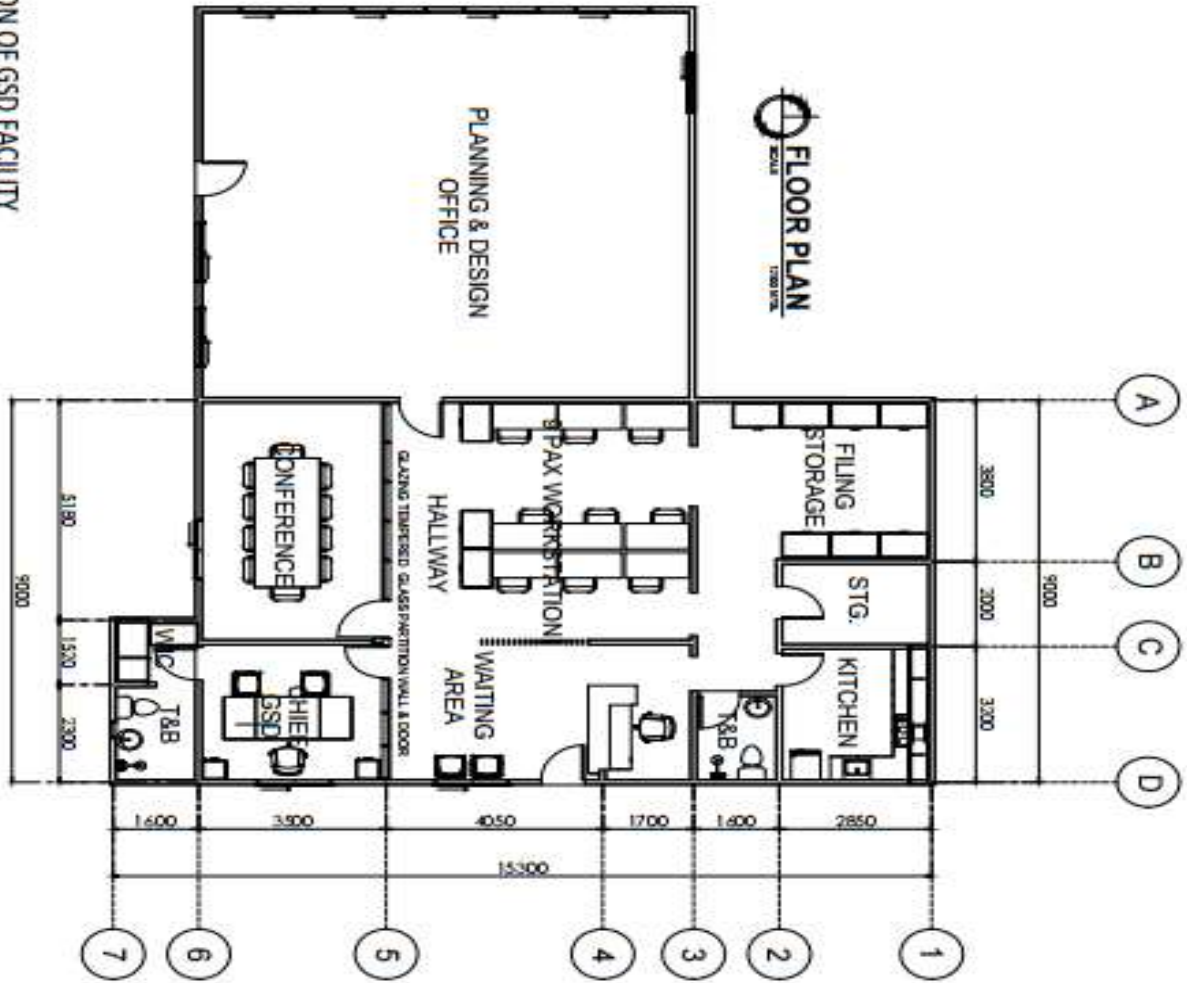

CONFORME:

Name of Company in Print

Signature Over Printed Name of Authorized Representative/Date

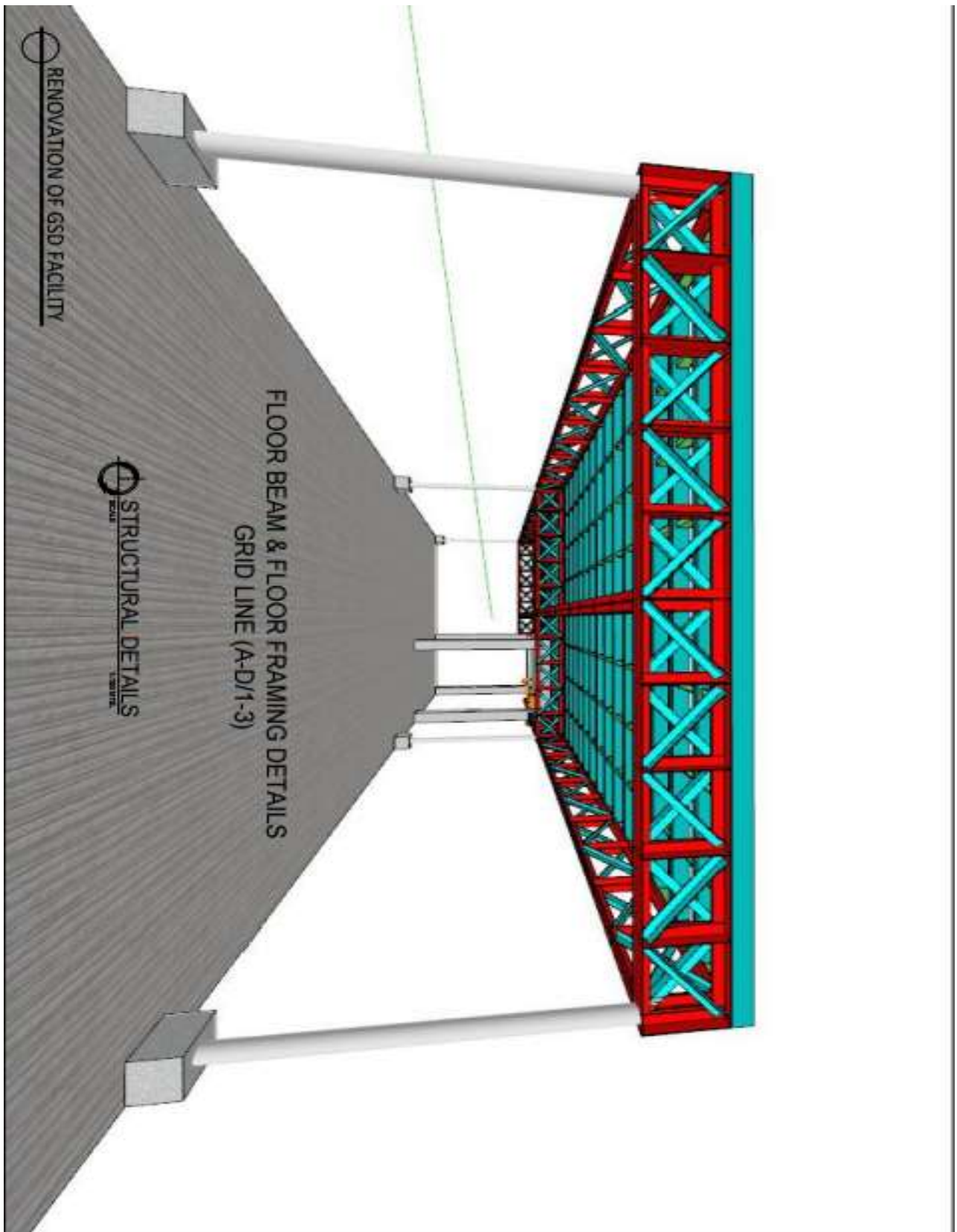

CONFORME:

Name of Company in Print

Signature Over Printed Name of Authorized Representative/Date

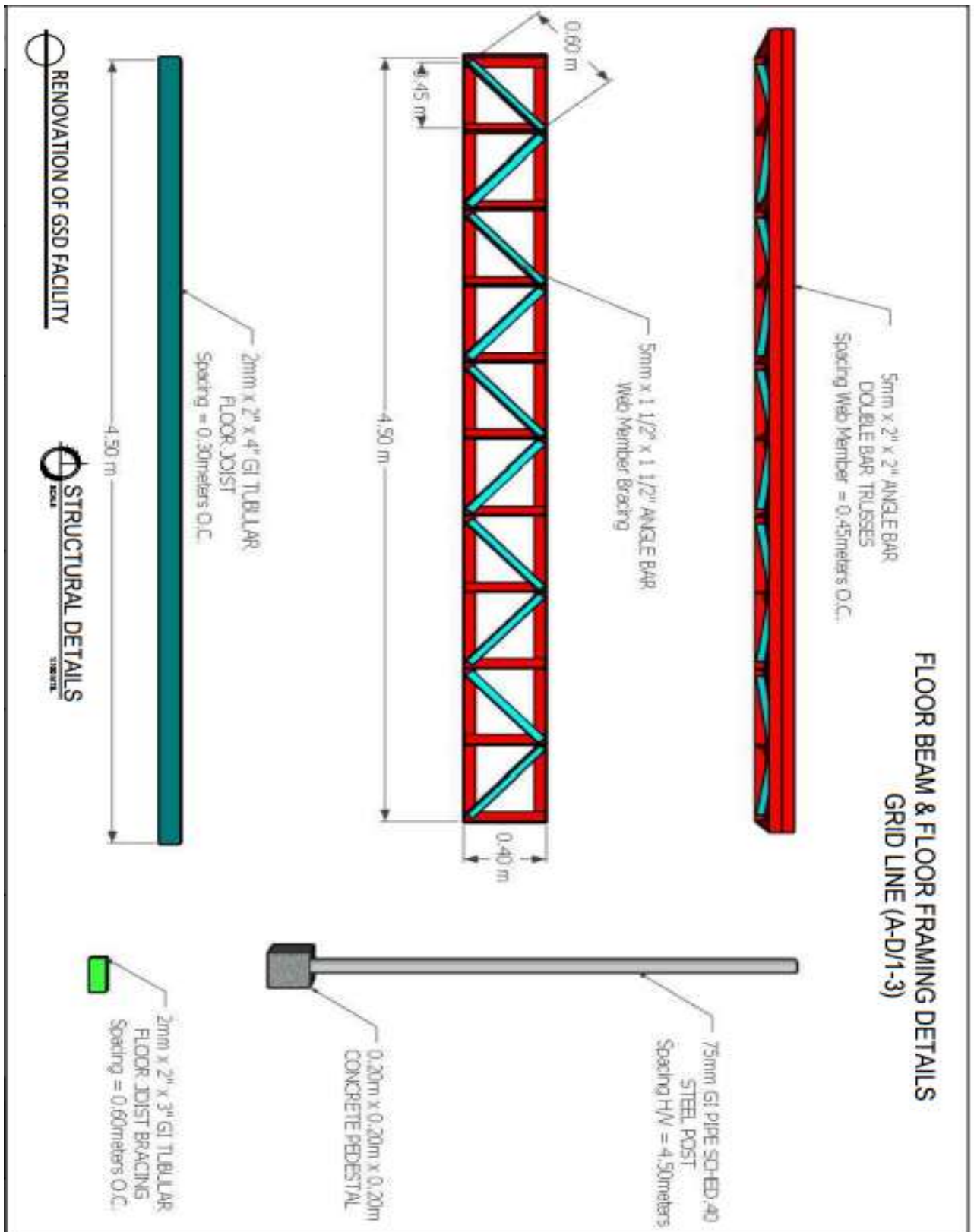

CONFORME:

Name of Company in Print

Signature Over Printed Name of Authorized Representative/Date

**FLOOR FRAMING DETAILS
GRID LINE (A-D/1-3)**

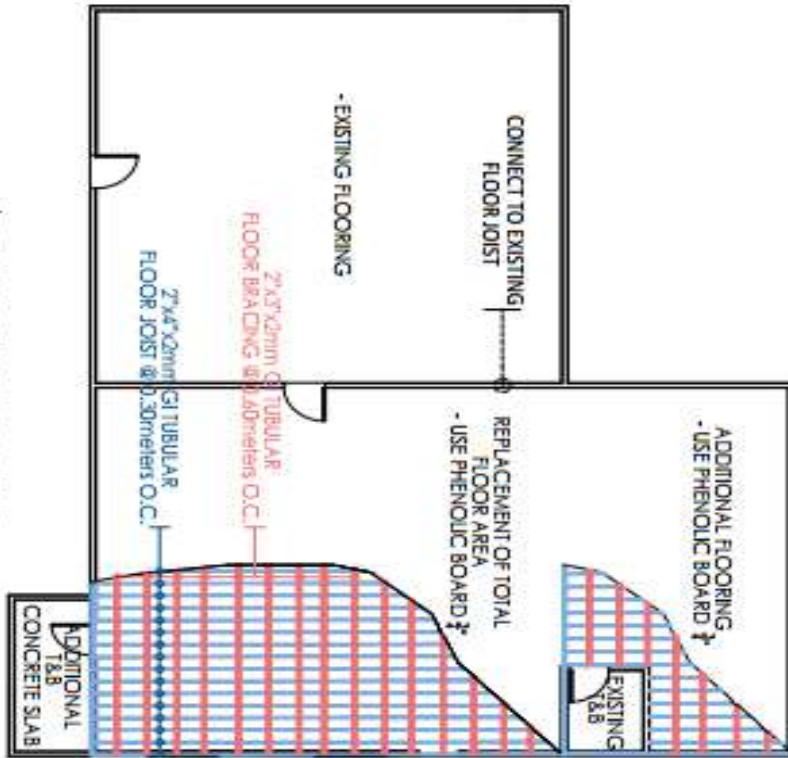

STRUCTURAL DETAILS
SINCE 1982

RENOVATION OF GSD FACILITY

**FLOOR, CEILING AND PARTITION WALL DETAILS
GRID LINE (A-D/1-3)**

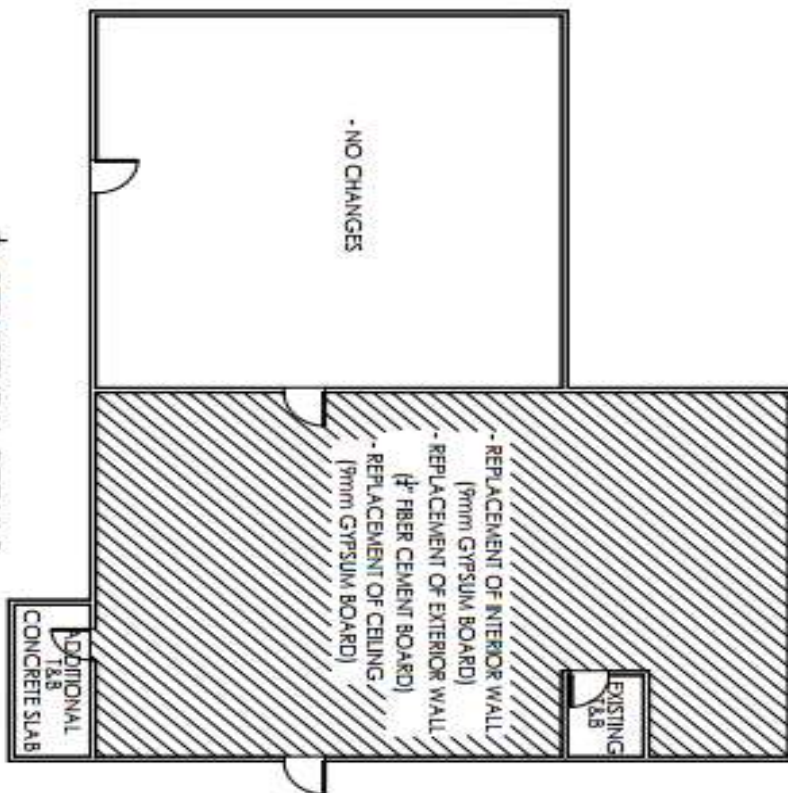

STRUCTURAL DETAILS
SINCE 1982

CONFORME:

Name of Company in Print

Signature Over Printed Name of Authorized Representative/Date

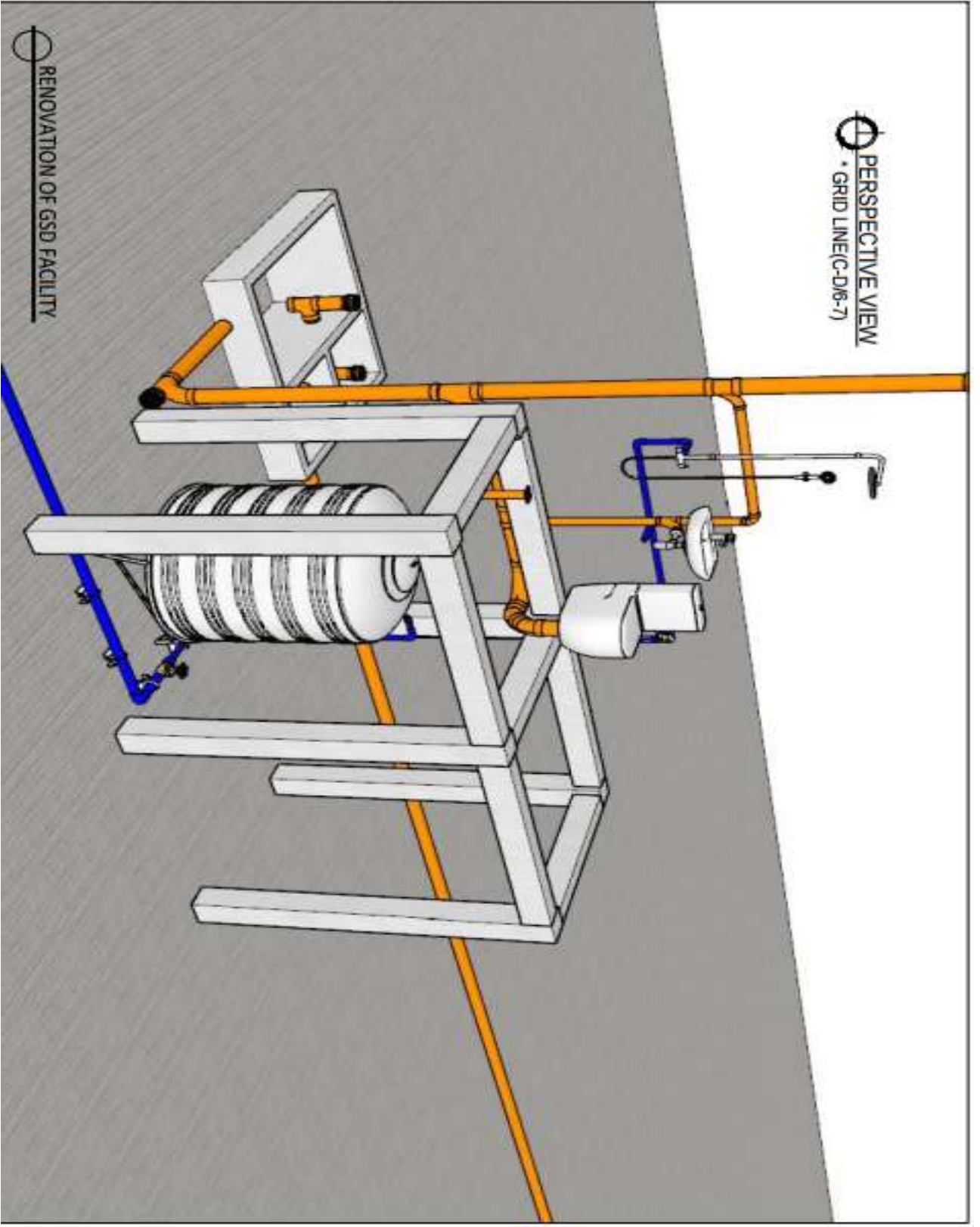

CONFORME:

Name of Company in Print

Signature Over Printed Name of Authorized Representative/Date

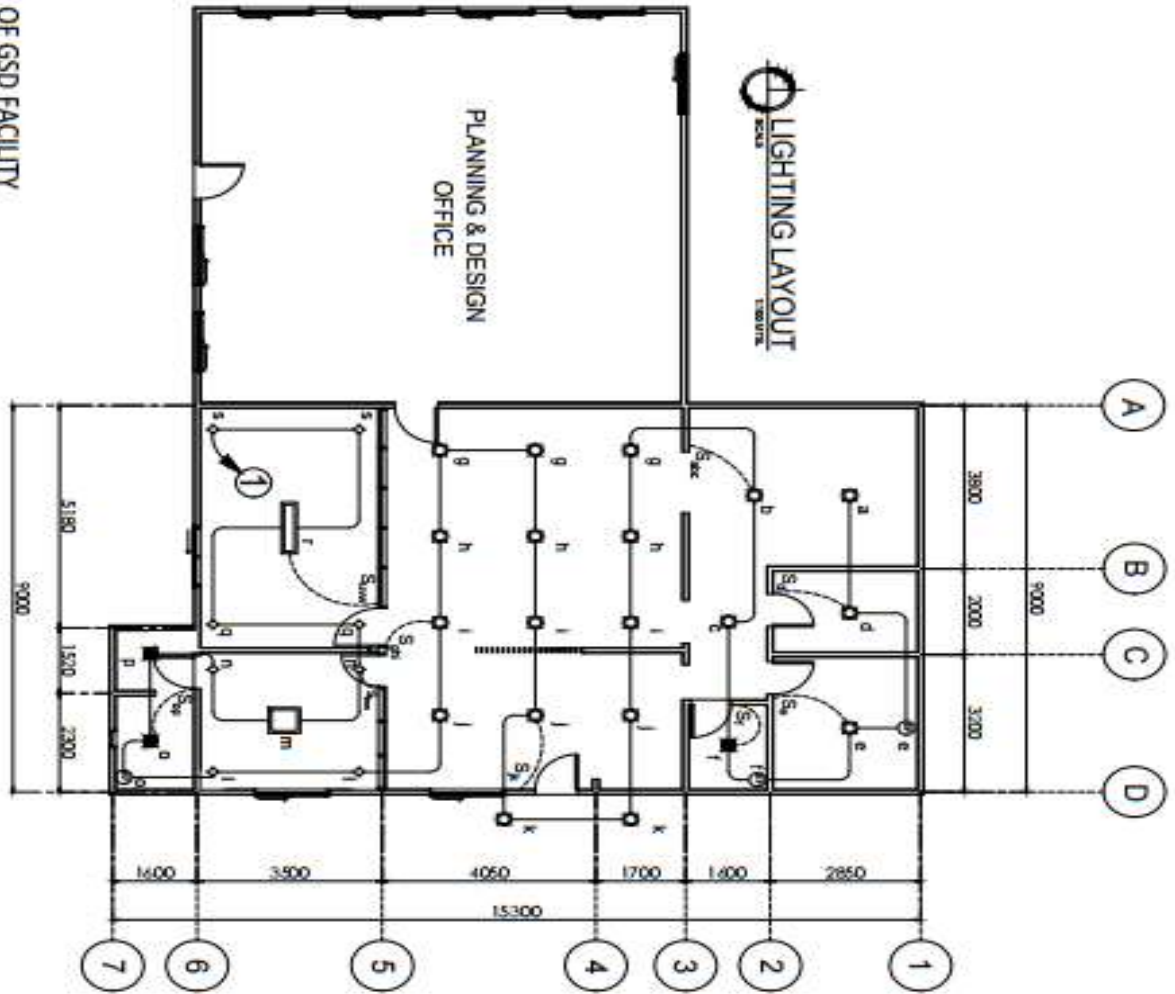

CONFORME:

Name of Company in Print

Signature Over Printed Name of Authorized Representative/Date

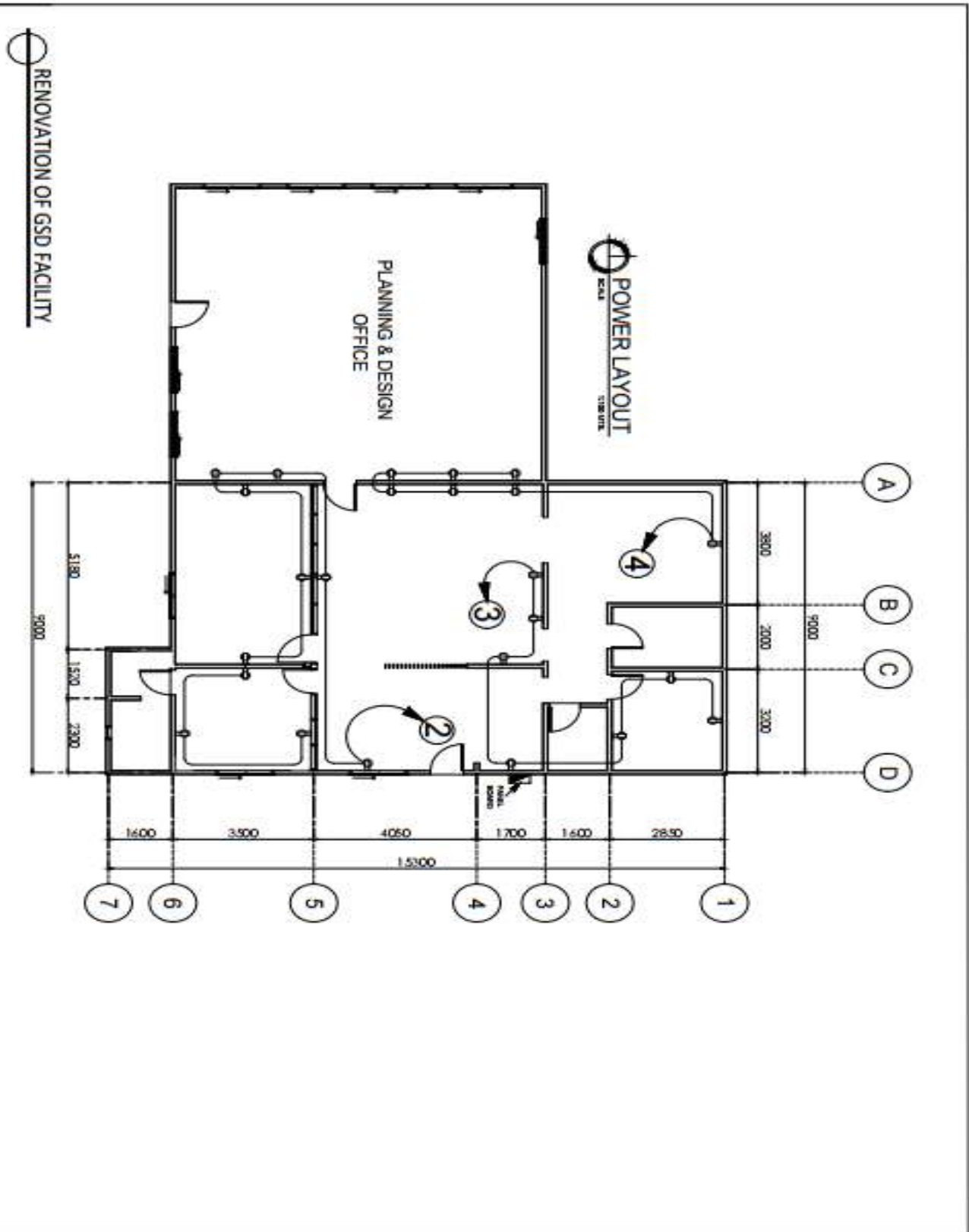

CONFORME:

Name of Company in Print

Signature Over Printed Name of Authorized Representative/Date

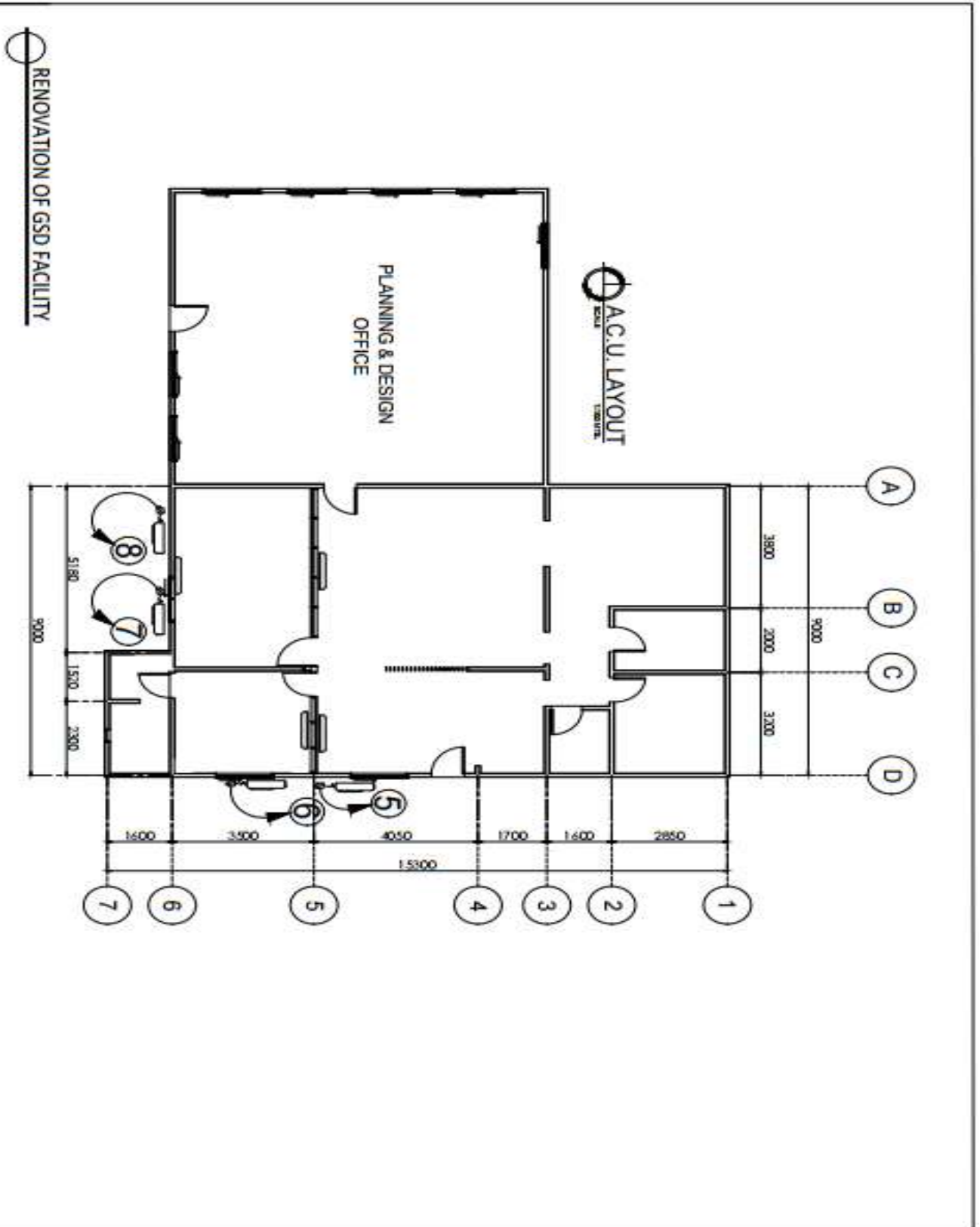

CONFORME:

Name of Company in Print

Signature Over Printed Name of Authorized Representative/Date

















GENERAL NOTES:

1. ALL ELECTRICAL WORKS HEREIN SHALL BE DONE IN ACCORDANCE WITH THE LATEST EDITION OF THE PHILIPPINE ELECTRICAL CODE AND THE NATIONAL BUILDING CODE, THE LAW AND ORDINANCE OF THE LOCAL ENGINEERING ADMINISTRATORS AND THE REQUIREMENTS OF LOCAL UTILITY COMPANIES SERVING THE SITE.
2. THE ELECTRICAL SERVICE POWER SUPPLY SHALL HAVE A 220V, 60HZ, 1Φ, 2-WIRE + GROUND.
3. FOR ALL PROTECTIVE DEVICES OR CIRCUIT BREAKERS, IT SHALL BE OF ONE BRAND, 220V, 60HZ, RATED ON THE UNLESS SPECIFIED OTHERWISE.
4. THE WIRING SHALL BE USED SHALL BE NEW AND OF THE APPROVED TYPE FOR THE LOCATION AND PURPOSE FOR WHICH THEY ARE INTENDED.
5. ALL PANELBOARDS SHALL BE PROVIDED WITH OVERLOAD TERMINAL STRIPS BOUND TO THE PANEL ENCLOSURE AND TO THE SERVICE OR BRANCH FEEDER TERMINALS OF WHICH QUANTITY SHALL BE EQUAL TO THE NUMBER OF CIRCUITS, INCLUDING SPARES, SHALL BE PROVIDED ON THE GROUND TERMINAL STRIPS.
6. THE CIRCUIT TO BE USED MUST BE USED NEAR CONDUITWAYS FOR MAIN FEEDER LINE AND POLYMER COLOURED PVC FOR THE BRANCH CIRCUIT.
7. THE ELECTRICAL CONTRACTOR SHALL COORDINATE WITH LOCAL ELECTRICAL UTILITY CONCERNING UNDERGROUND WORKS, IF NECESSARY.
8. ANY WIRELASS AND FITTINGS NOT SHOWN ON THIS PLAN BUT NECESSARY/REQUIRED TO COMPLETE THE SYSTEM AND OPERATION OF THE PROJECT SHALL BE INCLUDED IN THE CONTRACTOR'S SCOPE OF WORK.
9. ANY INCONSISTENCY IN LOCATION AND DIMENSIONS OF EQUIPMENT AND APPURTENANCES SHALL BE VERIFIED WITH THE OPERATING/USER OR ANY OF HIS REPRESENTATIVE AND CHANGES.
10. ALL ELECTRICAL WORKS HEREIN SHALL BE DONE UNDER THE DIRECT SUPERVISION OF A DAILY QUALIFIED AND LICENSED REGISTERED ELECTRICAL ENGINEER AND MICROSED UNDER ELECTRICIAN.
11. SUBMISSION OF AN ACCOUNT RECEIPT PLANS.

INSTALLATION STANDARDS:

1. THE ELECTRICAL WORKS/CONSTRUCTION SHALL CONFORM WITH THE LATEST EDITION OF THE PHILIPPINE ELECTRICAL CODES.
2. THE PROVED EQUIPMENT OR COMPONENTS & LOGICUS IN TERMINATION OF CONDUITS TO BOXES, PULLBOXES & ENCLOSURES SHALL BE USED.
3. USE PROPER WIRING & COMPLETE SETS OF SYSTEMS IN FORM/MOUNTING THE OUTLETS, COVER OF BOXES, PANELBOARDS & MOUNTINGS.
4. THE INTERIOR OF OUTLETS, BOXES, PANELBOARDS, UPS & CAN MUST BE CLEAN BEFORE THE INSTALLATION OF ELECTRICAL WIRING & COVERS.
5. THE REGULATION OF PROPER TIGHTING ON THE POWER OUTLETS, PHONE & DATA TERMINALS IS STRICTLY ENFORCED.
6. A PVC CONDUIT MUST BE USED IN CONNECTING PVC PIPES AND FITTINGS.
7. ALL WIRINGS TO BE USED MUST BE NEW & ACCEPTABLE.
8. ANY WIRINGS USE NOT SPECIFIED IN THE SPECIFICATION MAY BE ALLOWED PROVIDED THAT SUCH SPECIFIC WIRINGS ARE PROVEN TO BE EQUAL AND/OR SUPERIOR IN QUALITY & MUST HAVE PROOF APPROVAL.
9. THE APPROPRIATE TOOLS AND TESTING EQUIPMENT MUST BE USED IN ALL WORKS.
10. PROTECT PROTECTING AND FITTING TO ALL PANELBOARD.
11. THE NUMBER OF CONDUCTORS AND INSULATED WIRING IN A SINGLE TERMINAL/TYPE SHALL NOT EXCEED THE PERMITTED REGULATION STANDARDS THAT IS BASED ON THE NYPELWIRING ELECTRICAL CODES/TYPE.
12. STRIPING AND PROPER PIPING SUPPORTS MUST BE PROVIDED AND ALL WIRING SHALL BE WITH PROPER SEES OF 3-SECTIONS IS REQUIRED.
13. CONDUIT AND RIGHT SECTIONS OF PANEL DIRECTORIES AND CIRCUIT MARKINGS IS REQUIRED.
14. THE CHANGING SYSTEM SHOULD BE MADE OF COULM GREEN INSULATED COPPER WIRE.
15. OPERANCY OF SAFETY AND CLEANNESS IN THE WORKING AREA SHOULD BE STRICTLY OBSERVED.

ELECTRICAL LEGENDS AND SYMBOLS

	DIMMABLE PANEL LIGHT (DOWNWARD ARROW IN SQUARE, RECESSED, DIMMABLE)		THREE DIMMABLE SWITCH
	DIMMABLE PANEL LIGHT (SQUARE, RECESSED, DIMMABLE)		THREE DIMMABLE SWITCH
	DIMMABLE PANEL LIGHT (CIRCLE, RECESSED, DIMMABLE)		DIMMABLE PANEL SWITCH
	DIMMABLE PANEL LIGHT (SQUARE, RECESSED, DIMMABLE WITH DOT)		DIMMABLE PANEL BOARD (WITH GROUNDING BUS BAR)
	DIMMABLE PANEL LIGHT (SQUARE, RECESSED, DIMMABLE WITH DOT)		DIMMABLE PANEL BOARD (WITH GROUNDING BUS BAR)
	DIMMABLE PANEL LIGHT (SQUARE, RECESSED, DIMMABLE WITH DOT)		DIMMABLE PANEL BOARD (WITH GROUNDING BUS BAR)
	DIMMABLE PANEL LIGHT (SQUARE, RECESSED, DIMMABLE WITH DOT)		DIMMABLE PANEL BOARD (WITH GROUNDING BUS BAR)
	DIMMABLE PANEL LIGHT (SQUARE, RECESSED, DIMMABLE WITH DOT)		DIMMABLE PANEL BOARD (WITH GROUNDING BUS BAR)

CONFORME:

Name of Company in Print

Signature Over Printed Name of Authorized Representative/Date

PANEL BOARD

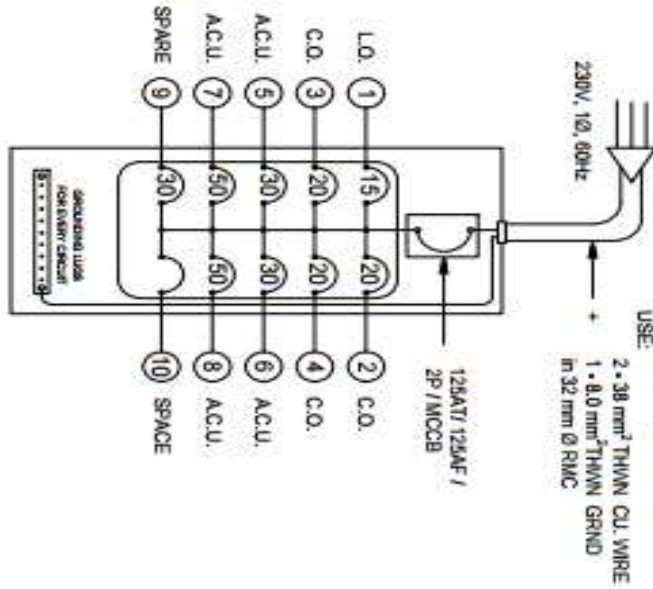

PANEL BOARD SCHEDULE OF LOADS

PANEL NAME : **PANEL-11E** SYSTEM : **230V, 1Ø, 60Hz** BRANCH KW/C : **10**
 ENCLOSURE : **META-30** MOUNTING : **INDUSTRIAL/COMMERCIAL**

CIRCUIT No.	LOAD DESCRIPTION	VA	VOLT	A	CIRCUIT BREAKER			SIZE OF WIRE	SIZE OF CONDUIT	TYPE
					AT	AF	P			
1	3Ø L.O.R.F.	1170	230	1.61	15	125	2	2-2.6mm. Øs. THHN + 2.0mm. Øs. THHN	15mm Ø	PVC
2	C.O.	2092	230	15.62	30	125	2	2-3.6mm. Øs. THHN + 2.0mm. Øs. THHN	15mm Ø	PVC
3	C.O.	2510	230	10.92	30	125	2	2-3.5mm. Øs. THHN + 2.0mm. Øs. THHN	15mm Ø	PVC
4	C.O.	2510	230	10.92	30	125	2	2-3.5mm. Øs. THHN + 2.0mm. Øs. THHN	15mm Ø	PVC
5	1 HP A.C.U.	1640	230	8.02	30	125	2	2-3.5mm. Øs. THHN + 2.0mm. Øs. THHN	15mm Ø	PVC
6	1.5 HP A.C.U.	2300	230	10.00	30	125	2	2-3.5mm. Øs. THHN + 2.0mm. Øs. THHN	15mm Ø	PVC
7	2.5 HP A.C.U.	3912	230	17.00	40	125	2	2-6.0mm. Øs. THHN + 2.0mm. Øs. THHN	20mm Ø	PVC
8	2.5 HP A.C.U.	3912	230	17.00	40	125	2	2-6.0mm. Øs. THHN + 2.0mm. Øs. THHN	20mm Ø	PVC
9	SPACE	2100	230	9.13	30	125	2			
10	SPACE									
TOTAL CIRCUIT				106.36						
TOTAL CONNECTED LOAD (VA)				24,430						

MAIN D.F. : **10,500.00 VA**
 WIRE : **10mm** X **125** = **106.36**
 FEEDER : **2.38mm. Øs. THWN + 8.0mm. Øs. THWN**
 CONDUIT SIZE : **30mm Ø RMC**
 MAIN CB : **125A/125MVA 2P 1Ø/1.0V. 1Ø/2Ø**

PANEL BOARD AND SCHEDULE OF LOAD DETAIL

CONFORME:

Name of Company in Print

Signature Over Printed Name of Authorized Representative/Date

Section VIII. Bill of Quantities



Republic of the Philippines
Department of Justice
BUREAU OF CORRECTIONS
Muntinlupa City



RENOVATION OF GSD FACILITY

BUREAU OF CORRECTIONS, NBP RESERVATION, MUNTINLUPA CITY

Source of Fund: GoP

Implementation: By Contract

BILL OF QUANTITIES

ITEM	DESCRIPTION	Qty	Unit	Unit Cost	Amount
1	General Requirements	1	Lot		
2	Other General Requirements	1	Lot		
3	Welding Works	1	Lot		
4	Carpentry Works	400	sqm		
5	Civil / Structural Works	1	Lot		
6	Masonry Works	30	sqm		
7	Roofing Works	1	Lot		
8	Tile Works	24	sqm		
9	Plumbing Works	1	Lot		
10	Electrical Works	1	Lot		
11	Doors, Windows, Glass Partition and Furnitures	1	Lot		
12	Paint Works	550	sqm		
Total Direct Cost:					
Overhead,Contingencies, Miscellaneous 15%:					
Contractor's Profit 10% :					
VAT 5%					
ABC:					

Submitted by:

Contractor/Authorized Representatives

Section IX. Checklist of Technical and Financial Documents

Checklist of Technical and Financial Documents

I. TECHNICAL COMPONENT ENVELOPE

Class "A" Documents

Legal Documents

- (a) Valid PhilGEPS Registration Certificate (Platinum Membership) (all pages);

Technical Documents

- (b) Statement of the prospective bidder of all its ongoing government and private contracts, including contracts awarded but not yet started, if any, whether similar or not similar in nature and complexity to the contract to be bid; **and**
- (c) Statement of the bidder's Single Largest Completed Contract (SLCC) similar to the contract to be bid, except under conditions provided under the rules; **and**
- (d) Original copy of Bid Security. If in the form of a Surety Bond, submit also a certification issued by the Insurance Commission;
or
Original copy of Notarized Bid Securing Declaration; **and**
- (e) Project Requirements, which shall include the following:
- a. Organizational chart for the contract to be bid;
- b. List of contractor's key personnel (*e.g.*, Project Manager, Project Engineers, Materials Engineers, and Foremen), to be assigned to the contract to be bid, with their complete qualification and experience data;
- c. List of contractor's major equipment units, which are owned, leased, and/or under purchase agreements, supported by proof of ownership or certification of availability of equipment from the equipment lessor/vendor for the duration of the project, as the case may be; **and**
- (f) Original duly signed Omnibus Sworn Statement (OSS); **and** if applicable, Original Notarized Secretary's Certificate or Board Resolution or Partnership Resolution in case of a corporation, partnership, or cooperative; or Original Special Power of Attorney of all members of the joint venture giving full power and authority to its officer to sign the OSS and do acts to represent the Bidder.
- (g) Conformity with the Technical Specifications (Scope of Work); **and**
- (h) Conformity with the Plans/Drawings.

Financial Documents

- (i) The prospective bidder's computation of Net Financial Contracting Capacity (NFCC).

Class "B" Documents

- (j) If applicable, duly signed joint venture agreement (JVA) in accordance with RA No. 4566 and its IRR in case the joint venture is already in existence;
or
duly notarized statements from all the potential joint venture partners stating that they will enter into and abide by the provisions of the JVA in the instance that the bid is successful.

II. FINANCIAL COMPONENT ENVELOPE

- (k) Original of duly signed and accomplished Financial Bid Form; **and**

Other documentary requirements under RA No. 9184

- (l) Original of duly signed Bid Prices in the Bill of Quantities; **and**
- (m) Duly accomplished Detailed Estimates Form, including a summary sheet indicating the unit prices of construction materials, labor rates, and equipment rentals used in coming up with the Bid; **and**
- (n) Cash Flow by Quarter.

Bidding Form

COMPANY LETTERHEAD

Statement of ongoing government & private contracts

Renovation of GSD Facility

Statement of all its ongoing government and or private contracts including contracts awarded but not yet started, if any whether similar or not similar in nature.

Name of Contract	Date of contract	Contract Duration	Owner's Name and Address	Nature of work	contractor's role (whether sole contractor, subcontractor, or partner in a JV) and percentage of participation	total contract value at award	date of completion or estimated completion time	value of outstanding works

CERTIFIED CORRECT:

Name and Signature of Authorized Representative

Position

Date

COMPANY LETTERHEAD

Statement of Single Largest Completed Contract

Renovation of GSD Facility

Statement of Single (1) Largest Completed Contract of Similar in nature within the last four (4) years from the date of submission and receipt of bids amounting to at least fifty percent (50%) of the Approved Budget of the Contract (ABC)

Name of Contract	Date of contract	Contract Duration	Owner's Name and Address	Nature of work	contractor's role (whether sole contractor, subcontractor, or partner in a JV) and percentage of participation	total contract value at award	date of completion or estimated completion time

CERTIFIED CORRECT:

Name and Signature of Authorized Representative

Position

Date

COMPANY LETTERHEAD

Renovation of GSD Facility

REPUBLIC OF THE PHILIPPINES)
CITY OF _____) S.S.

x-----x

BID SECURING DECLARATION
Invitation to Bid: *[Insert Reference number]*

To: **Bureau of Corrections**

I/We, the undersigned, declare that:

1. I/We understand that, according to your conditions, bids must be supported by a Bid Security, which may be in the form of a Bid-Securing Declaration.
2. I/We accept that: (a) I/we will be automatically disqualified from bidding for any contract with any procuring entity for a period of two (2) years upon receipt of your Blacklisting order; and, (b) I/we will pay the applicable fine provided under Section 6 of the Guidelines on the Use of Bid Securing Declaration, within fifteen (15) days from receipt of the written demand by the procuring entity for the commission of acts resulting to the enforcement of the bid securing declaration under Sections 23.1(b), 34.2, 40.1 and 69.1, except 69.1(f), of the IRR of RA 9184; without prejudice to other legal action the government may undertake.
3. I/We understand that this Bid Securing Declaration shall cease to be valid on the following circumstances:
 - (a) Upon expiration of the bid validity period, or any extension thereof pursuant to your request;
 - (b) I am/we are declared ineligible or post-disqualified upon receipt of your notice to such effect, and (i) I/we failed to timely file a request for reconsideration or (ii) I/we filed a waiver to avail of said right;
 - (c) I am/we are declared the bidder with the Lowest Calculated Responsive Bid, and I/we have furnished the performance security and signed the Contract.

IN WITNESS WHEREOF, I/We have hereunto set my/our hand/s this ____ day of [month] [year] at [place of execution].

[Insert NAME OF BIDDER'S AUTHORIZED REPRESENTATIVE]

[Insert Signatory's Legal Capacity]
Affiant

SUBSCRIBED AND SWORN to before me this ____ day of *[month]* *[year]* at *[place of execution]*, Philippines. Affiant/s is/are personally known to me and was/were identified by me through competent evidence of identity as defined in the 2004 Rules on Notarial Practice (A.M. No. 02-8-13-SC). Affiant/s exhibited to me his/her *[insert type of government identification card used]*, with his/her photograph and signature appearing thereon, with no. _____ issued on _____ at _____.

Witness my hand and seal this ____ day of *[month]* *[year]*.

NAME OF NOTARY PUBLIC

Serial No. of Commission _____

Notary Public for _____ until _____

Roll of Attorneys No. _____

PTR No. _____ *[date issued]*, *[place issued]*

IBP No. _____ *[date issued]*, *[place issued]*

Doc. No. _____

Page No. _____

Book No. _____

Series of _____

COMPANY LETTERHEAD
Renovation of GSD Facility
Omnibus Sworn Statement

REPUBLIC OF THE PHILIPPINES)
CITY/MUNICIPALITY OF _____) S.S.

AFFIDAVIT

I, *[Name of Affiant]*, of legal age, *[Civil Status]*, *[Nationality]*, and residing at *[Address of Affiant]*, after having been duly sworn in accordance with law, do hereby depose and state that:

1. ***Select one, delete the other:***

If a sole proprietorship: I am the sole proprietor or authorized representative of *[Name of Bidder]* with office address at *[address of Bidder]*;

If a partnership, corporation, cooperative, or joint venture: I am the duly authorized and designated representative of *[Name of Bidder]* with office address at *[address of Bidder]*;

2. ***Select one, delete the other:***

a) *If a sole proprietorship:* As the owner and sole proprietor, or authorized representative of *[Name of Bidder]*, I have full power and authority to do, execute and perform any and all acts necessary to participate, submit the bid, and to sign and execute the ensuing contract for ***Renovation of GSD Facility*** of the **Bureau of Corrections**, as shown in the attached duly notarized *Special Power of Attorney*;

b) *If a partnership, corporation, cooperative, or joint venture:* I am granted full power and authority to do, execute and perform any and all acts necessary to participate, submit the bid, and to sign and execute the ensuing contract for ***Renovation of GSD Facility*** of the **Bureau of Corrections**, as shown in the attached *[state title of attached document showing proof of authorization (e.g., duly notarized Secretary's Certificate, Board/Partnership Resolution, or Special Power of Attorney, whichever is applicable;)]*;

3. *[Name of Bidder]* is not "blacklisted" or barred from bidding by the Government of the Philippines or any of its agencies, offices, corporations, or Local Government Units, foreign government/foreign or international financing institution whose blacklisting rules have been recognized by the Government Procurement Policy Board by itself or by relation, membership, association, affiliation, or controlling interest with another blacklisted person or entity as defined and provided for in the Uniform Guidelines on Blacklisting ;

4. Each of the documents submitted in satisfaction of the bidding requirements is an authentic copy of the original, complete, and all statements and information provided therein are true and correct;

5. *[Name of Bidder]* is authorizing the Head of the Procuring Entity or its duly authorized representative(s) to verify all the documents submitted;

6. ***Select one, delete the rest:***

If a sole proprietorship: The owner or sole proprietor is not related to the Head of the Procuring Entity, members of the Bids and Awards Committee (BAC), the Technical Working Group, and the BAC Secretariat, the head of the Project Management Office or the end-user unit, and the project consultants by consanguinity or affinity up to the third civil degree;

If a partnership or cooperative: None of the officers and members of *[Name of Bidder]* is related to the Head of the Procuring Entity, members of the Bids and Awards Committee (BAC), the Technical Working Group, and the BAC Secretariat, the head of the Project Management Office or the end-user unit, and the project consultants by consanguinity or affinity up to the third civil degree;

If a corporation or joint venture: None of the officers, directors, and controlling stockholders of *[Name of Bidder]* is related to the Head of the Procuring Entity, members of the Bids and Awards Committee (BAC), the Technical Working Group, and the BAC Secretariat, the head of the Project Management Office or the end-user unit, and the project consultants by consanguinity or affinity up to the third civil degree;

7. *[Name of Bidder]* complies with existing labor laws and standards; and

8. *[Name of Bidder]* is aware of and has undertaken the following responsibilities as a Bidder:

- a) Carefully examine all of the Bidding Documents;
- b) Acknowledge all conditions, local or otherwise, affecting the implementation of the Contract;
- c) Made an estimate of the facilities available and needed for the contract to be bid, if any; and
- d) Inquire or secure Supplemental/Bid Bulletin(s) issued for the ***Renovation of GSD Facility.***

9. *[Name of Bidder]* did not give or pay directly or indirectly, any commission, amount, fee, or any form of consideration, pecuniary or otherwise, to any person or official, personnel or representative of the government in relation to any procurement project or activity.

10. In case advance payment was made or given, failure to perform or deliver any of the obligations and undertakings in the contract shall be sufficient grounds to constitute criminal liability for Swindling (Estafa) or the commission of fraud with unfaithfulness or abuse of confidence through misappropriating or converting any payment received by a person or entity under an obligation involving the duty to

deliver certain goods or services, to the prejudice of the public and the government of the Philippines pursuant to Article 315 of Act No. 3815 s. 1930, as amended, or the Revised Penal Code.

IN WITNESS WHEREOF, I have hereunto set my hand this ___ day of ___, 2023 at _____, Philippines.

Bidder's Representative/Authorized Signatory

SUBSCRIBED AND SWORN to before me this ___ day of [month] [year] at [place of execution], Philippines. Affiant/s is/are personally known to me and was/were identified by me through competent evidence of identity as defined in the 2004 Rules on Notarial Practice (A.M. No. 02-8-13-SC). Affiant/s exhibited to me his/her [insert type of government identification card used], with his/her photograph and signature appearing thereon, with no. _____ and issued on _____ at _____.

Witness my hand and seal this ___ day of [month] [year].

NAME OF NOTARY PUBLIC

Serial No. of Commission _____

Notary Public for _____ until _____

Roll of Attorneys No. _____

PTR No. _____ [date issued], [place issued]

IBP No. _____ [date issued], [place issued]

Doc. No. _____

Page No. _____

Book No. _____

Series of _____

COMPANY LETTERHEAD

Certificate of Net Financial Contracting Capacity

Renovation of GSD Facility

(Please show figures at how you arrived at the NFCC)

This is to certify that our Net Financial Contracting Capacity (NFCC) is _____ (P _____) which is at least equal to the total ceiling price we are bidding. The amount is computed as follows: (Please show computation of NFCC)

$$\text{NFCC} = (\text{CA}-\text{CL}) (15) - \text{C}$$

Where:

CA = Current Assets

CL = Current Liabilities

C = value of all outstanding or uncompleted portions of the Projects under going contracts, including awarded contracts Yet to be started coinciding with the contract for this Project

NOTE:

The values of the bidder's current assets and current liabilities shall be based on the Audited Financial Statement submitted to the BIR.

Issued this _____ day of _____, 2023

Name & Signature of Authorized Representative

Position

Date

COMPANY LETTERHEAD

Bid Form

Date: _____

IB N^o: _____

To **Bids and Awards committee**
Bureau of Corrections
NBP Reservation Muntinlupa City

We, the undersigned, declare that:

- (a) We have examined and have no reservation to the Bidding Documents, including Addenda, for the Contract **Renovation of GSD Facility** ;
- (b) We offer to execute the Works for this Contract in accordance with the Bid and Bid Data Sheet, General and Special Conditions of Contract accompanying this Bid;

The total price of our Bid, excluding any discounts offered below is:
_____ ₱ _____;

The discounts offered and the methodology for their application are: *[insert information]*;

- (c) Our Bid shall be valid for a period of 120 calendar days from the date fixed for the Bid submission deadline in accordance with the Bidding Documents, and it shall remain binding upon us and may be accepted at any time before the expiration of that period;
- (d) If our Bid is accepted, we commit to obtain a Performance Security in the amount of 30% percent of the Contract Price for the due performance of the Contract;
- (e) Our firm, including any subcontractors or suppliers for any part of the Contract, have nationalities from the following eligible countries;
- (f) We are not participating, as Bidders, in more than one Bid in this bidding process, other than alternative offers in accordance with the Bidding Documents;
- (g) Our firm, its affiliates or subsidiaries, including any subcontractors or suppliers for any part of the Contract, has not been declared ineligible by the Funding Source;
- (h) We understand that this Bid, together with your written acceptance thereof included in your notification of award, shall constitute a binding contract between us, until a formal Contract is prepared and executed; and
- (i) We understand that you are not bound to accept the Lowest Calculated Bid or any other Bid that you may receive.

- (j) **We likewise certify/confirm that the undersigned, is the duly authorized representative of the bidder, and granted full power and authority to do, execute and perform any and all acts necessary to participate, submit the bid, and to sign and execute the ensuing contract for the Renovation of GSD Facility of the Bureau of Corrections.**
- (k) **We acknowledge that failure to sign each and every page of this Bid Form, including the Bill of Quantities, shall be a ground for the rejection of our bid.**

Name: _____

In the capacity of: _____

Signed: _____

Duly authorized to sign the Bid for and on behalf of: _____

Date: _____

Republic of the Philippines



Government Procurement Policy Board